

the power to innovate

Dynamic Cable & Hose Carrier Systems

# TECHNICAL HANDBOOK

Third Edition





## Commonly Used Abbreviations & Symbols

$B_{EF}$  = Total width of cable carrier with glide buttons (K series) or glide shoes (QUANTUM)

$B_i$  = Usable inner carrier system cavity width

$B_k$  = Outer width of the cable carrier

$B_{St}$  = Stay width when using LG bar frame stay

$c$  = Distance between bored holes on LG bar frame stay

$d$  = Cable outer diameter

$D$  = Bored hole diameter when using LG bar frame stay

$d_R$  = Roller tube diameter when using RMR frame stay

$FE$  = The non-moving, fixed end of a carrier system

$FP$  = The fixed point of a carrier system

$H$  = Mounting height

$h_G$  = Outer link height

$h_G'$  = Outer link height when using glide shoes

$h_i$  = The inner carrier system cavity height

$KR$  = The bend radius of a carrier system

$L_B$  = The loop length (directly related to the  $KR$ )

$L_f$  = Unsupported cable carrier length

$L_k$  = The required/calculated carrier system length

$L_S$  = Total machine travel

$L_V$  = Fixed point offset from the center point of travel

$ME$  = The moving end of a carrier system

$n_Z$  = Number of comb tines on comb style strain relief

$q_Z$  = Additional load

$RKR$  = Reverse bend radius

$SF$  = Safety factor

$S_H$  = Horizontal separator/shelf thickness

$S_T$  = Vertical divider thickness

$t$  = Link pitch

$t_B$  = Elasticity factor

$\Sigma$  = Total sum

$\emptyset$  = Diameter

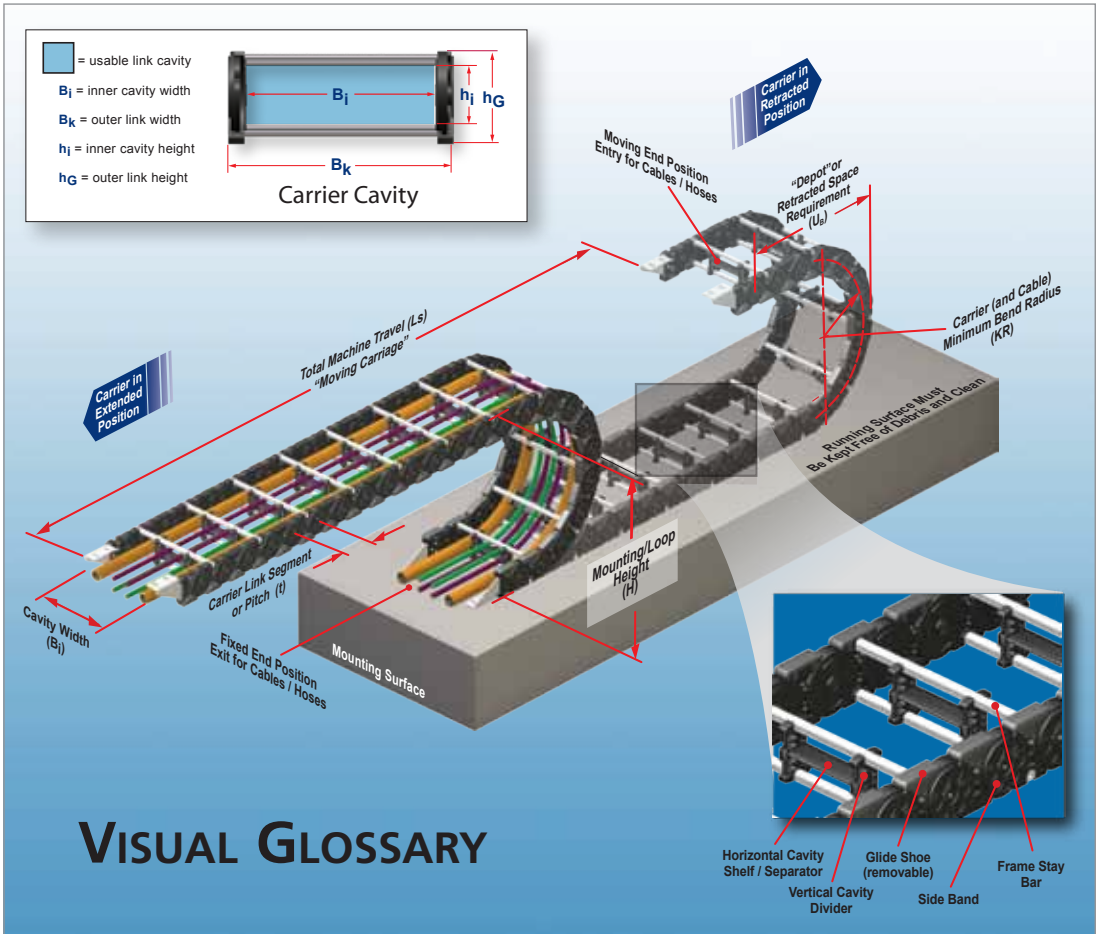

## VISUAL GLOSSARY

### Symbology

You will find these symbols used in this Technical Handbook to bring attention to important Rules of Thumb and Key Formulas.



= Rule of Thumb

A **Rule of Thumb** is a principle which applies in most cases but is not intended to be strictly accurate or reliable for every situation.



= Key Formula

A **Key Formula** is a standard formula used by KabelSchlepp to calculate critical dimensions and figures that are needed when specifying a cable and hose carrier system for an application.

### Commonly Used Conversions

Multiply	By	To Obtain
Millimeters	0.03937	Inches
Inches	25.4	Millimeters
Kilograms	2.205	Pounds
Pounds	0.4536	Kilograms
Feet/Second	0.305	Meters/Second
Meters/Second	3.28	Feet/Second
Kilograms/Meter	0.6720	Pounds/Foot
Pounds/Foot	1.488	Kilograms/Meter

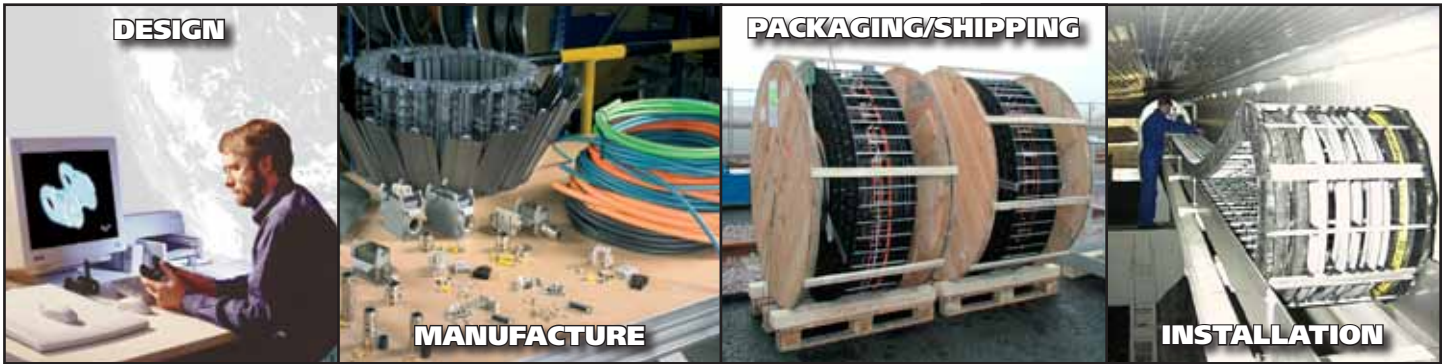

**In this section:**

**Pages**

**DESIGN PROCESS** A step-by-step guide toward designing a cable & hose carrier system for your application

**STEP 1:** Calculate the required cable and hose height (**h<sub>i</sub>**) and width (**B<sub>i</sub>**) clearance requirements for carrier system cavities.....2.04

**STEP 2:** Select the best carrier type, style and size for your application .....2.06

**STEP 3:** Select the proper carrier system minimum bend radius (**K<sub>R</sub>**) and applicable drive-arm mounting height (**H**).....2.08

**STEP 4:** Summarize and double check your selections. Have you considered everything?.....2.09

**STEP 5:** Determine the carrier system loop length (**L<sub>B</sub>**) .....2.09

**STEP 6:** Calculate the total carrier system length (**L<sub>K</sub>**).....2.09

**STEP 7:** Select mounting bracket style and mounting position .....2.10

**DESIGN CONSIDERATIONS** Use our experience and know-how to your advantage!

**SECTION 1:** Carrier frame stay system options .....2.12

**SECTION 2:** Cable and hose strain-relief systems.....2.13

**SECTION 3:** Know your cables and their specification details.....2.14

**SECTION 4:** Carrier system placement and operating mode options.....2.16

**SECTION 5:** Material properties of nylon polymer and metallic carrier systems in varying environmental conditions .....2.20

**SECTION 6:** Support tray and guidance for standard and circular cable and hose carrier system operating modes .....2.25

**SECTION 7:** Extended travel systems including guide channels, support rollers, rolling carriage systems and more .....2.27

**SECTION 8:** Things to consider when using high duty-cycle extended travel carrier systems .....2.36

**SECTION 9:** Important points to remember when designing a cable and hose carrier system .....2.37

**SECTION 10:** Proper installation and start-up of cable and hose carrier systems .....2.39

**SECTION 11:** Typical causes of cable and hose carrier system failures.....2.41

**SECTION 12:** Proper shipping, transport and storage procedures for cable and hose carrier systems .....2.44

**SECTION 13:** Suggested regular inspection procedures for all carrier systems.....2.45

**STEP 8:** Placing your order with KabelSchlepp .....2.46

**APPLICATION DATA & QUOTE REQUEST SHEET**

Let our skilled engineers help you select and order the best system solution for your application .....2.47

Specifications are subject to change without notice.  
KSA-0810-GC



# Step 1 Calculate The Required Cable And Hose Clearance Requirements For The Carrier System Cavity

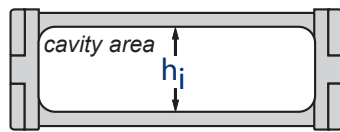
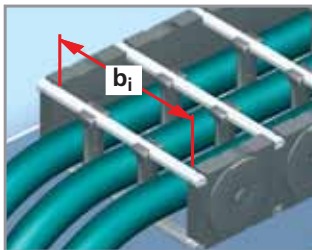

1.) To determine the required carrier system inner cavity height  $h_i$ , you must:

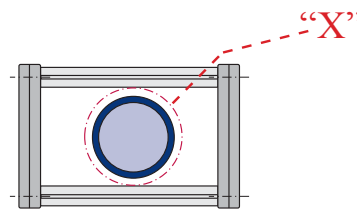

carrier link cross sectional view



a.) Add the following required clearance Safety Factor (SF) around all your cables, pneumatic lines, and/or hydraulic hoses:

-  **Cables** → Add 10% to the outside diameter  
minimum clearance around the O.D. = "X" must be > 1.0 mm
-  **Pneumatic Lines** → Add 15% to the outside diameter  
minimum clearance around the O.D. = "X" must be > 2.0 mm
-  **Hydraulic Hoses** → Add 20% to the outside diameter  
minimum clearance around the O.D. = "X" must be > 3.0 mm

b.) The largest of these cable, air line or fluid hose outer diameter values, with the safety factor added ( $\varnothing + SF$ ), determines the minimum inner cavity height required ( $h_i$ ).

- Make note of the largest  $c \varnothing + SF$ ,  $pn \varnothing + SF$  and  $hyd \varnothing + SF$  values in your application and use the largest of these as the minimum required  $h_i$  value.

2.) To determine the required carrier system inner cavity width ( $B_i$ )

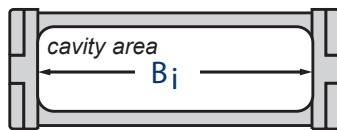
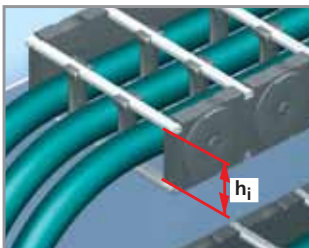

carrier link cross sectional view

a.) Add up all the aforementioned cables, air lines and fluid hoses plus safety factor values.

$$\sum c \varnothing + SF + \sum pn \varnothing + SF + \sum hyd \varnothing + SF = \sum ALL \varnothing$$

Cavity Fill		Weight Distribution	
good	not recommended	good	not recommended
Space in each cavity partition allows for the cable/hose outer diameter plus the recommended safety factor	Cable's/hose's outer diameter takes up the entire cavity causing premature wear on the cables/hoses and carrier system	Cable/hose weight is evenly/symmetrically distributed inside the carrier cavity allowing for balanced carrier system operation	Cable/hose weight is unevenly distributed inside the carrier cavity causing unbalanced carrier system operation which could result in system failure

Specifications are subject to change without notice.  
KSA-0810-GC

**b.) Use vertical cavity dividers for best overall operating results:**

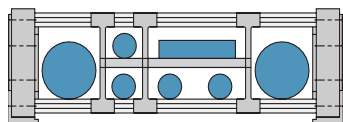

good

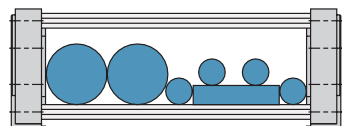

not recommended

- ✓ to keep unlike components apart
- ✓ to keep unlike cable or hose jacket materials apart
- ✓ when cable or hose outside diameters are less than 60% of the selected or available inner cavity total height (< 60% of  $h_i$ )
- ✓ individual flat cables must be kept separated, in a private compartment
- ✓ to prevent cable or hose tangling and damage
- ✓ to aid in maintaining the best left to right symmetrical weight distribution and balance of the carrier cavity contents
- ✓ maximum cavity fill should be less than or equal to 60% of cavity area
- ✓ if and when using horizontal shelving, you must not exceed the max. cavity fill criteria herein stated for each cavity created



Vertical dividers placed every link



Vertical dividers placed every 2nd link

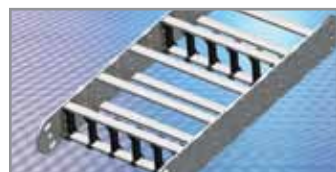

Vertical dividers placed every 3rd link



**max. cavity fill  $\leq 0.6 \times$  cavity area**

**c.)** If in accordance with the aforementioned recommendations for your particular application (step 2b), adding vertical dividers is required, add to the total value of  $\sum \text{ALL } \emptyset$  (step 2a) the total space required for all vertical cavity dividers ( $\sum \text{div}$ ) you deem necessary to best separate cables and hoses from one another (remember not all carrier types have dividers available, choose carefully).

- c1.)** Also determine if dividers should be installed at interval of every link, every 2nd, every 3rd or every 4th link / frame stay throughout the entire carrier system. Every 2nd link is used as our default interval. A maximum divider interval of every 1/2 meter through the entire length of the carrier is recommended.
- c2.)** If the resulting  $B_i$  is wider than the space available, stacking certain cables and/or hoses is possible when using horizontal shelving components seen in the KabelSchlepp catalog. All design rules and safety factors still apply. Please consult factory.
  - Make note of the total width ( $B_i$ ) value required for your application



$$\sum \text{ALL } \emptyset + \sum \text{div} = B_i$$

**Note:** The example worksheet below helps identify and calculate the cavity height ( $h_i$ ) and width ( $B_i$ ) required.

Cable or Hose Type	Applicable Cable or Hose Safety Factor Multiplier	Actual Cable or Hose Diameter(s) or Size	Cable or Hose Diameter with Safety Factor	Number of Cables or Hoses and Dividers	Actual Space Required
Air	1.15	1.00"	1.15"	4	4.60"
Cable	1.10	1.25"	1.38"	4	5.52"
Hydraulic	1.20	1.50"	1.80"	2	3.60"
			<b>1.80" = <math>h_i</math></b> (Min. Height)		Total from all above = 13.72
Dividers		.30		<b>9</b>	2.70
					Add numbers above
					<b>16.42 = <math>B_i</math></b> (Minimum Width)



## Step 2



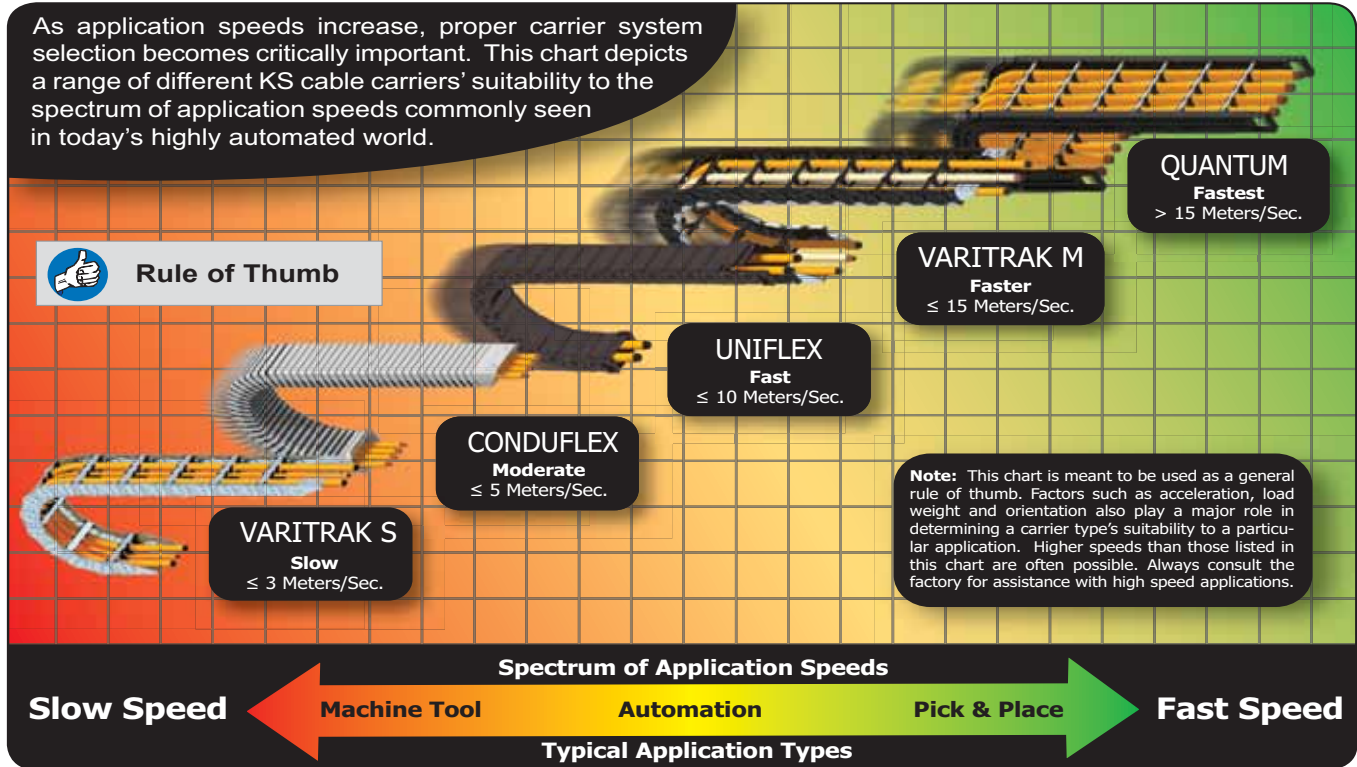

### Select The Best Carrier Type, Style & Size

To determine the best carrier system product group and type, select a carrier product group type and style that best suits your application needs, objectives and budget.

#### 1.) Basic selection criteria: Application Speed



#### 2.) Basic selection criteria: Type

MONO MOLDED PLASTIC	MODULAR PLASTIC / HYBRID	MODULAR EXTRUDED	3D MULTI-AXIS MOVEMENT	MODULAR STEEL
 <b>MICROTRAK, PLASTITRAK, UNIFLEX</b> Snap together links, moderate speed, extended travels, non-conductive, corrosion resistant, radiation resistant, easy to handle, light weight	 <b>VARITRAK K, MC, MK, MT MASTER HC, LC &amp; LT</b> Snap together side bands linked with various cable carrier cavity types, high speed, extended travels, non-conductive, low noise, clean-room rated, corrosion resistant, easy to handle, light weight	 <b>QUANTUM</b> Extruded one-piece side bands, highest speeds, clean-room rated, vibration free, quiet, non-conductive, corrosion resistant, multi-axis capable, lightest weight to size ratio <b>PROTUM</b> Extruded, press-in installation.	 <b>ROBOTRAX</b> Ideal for non-linear applications that require rotating, twisting, and other complex motions. Modular construction with press-in cavities for easy content installation, light weight, extra rugged	 <b>VARITRAK S</b> Modular construction, longest self-supporting spans, highest strength, heaviest loads <b>CONDUFLEX</b> (not pictured) Tube style, smooth running, stainless steel shell with polymer cavity liner

#### 3.) Basic selection criteria: Style

 <b>OPEN CARRIER</b> <b>MICROTRAK, PLASTITRAK, UNIFLEX, VARITRAK K, MK &amp; MC, PROFILE, QUANTUM, ROBOTRAX, PROTUM, MASTER HC &amp; LC</b> Debris passes through carrier, light weight, better cavity cooling properties than enclosed tube styles, allows examination of contents	 <b>ENCLOSED TUBE</b> <b>UNIFLEX BT, VARITRAK MT, VARITRAK S RMD, MASTER LT, CONDUFLEX</b> Contents are completely shielded from debris, contents hidden from view, red-hot chip protection, aesthetically pleasing
---	--

#### 4.) Basic design selection criteria: Mono or Modular

To determine the best cavity frame stay design (Mono or Modular) and size for the carrier type and style selected you must consider the following:

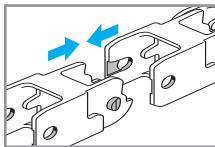

**a.) Mono Designs:** One or two piece molded links that snap together.

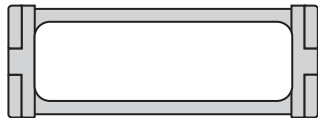

**1. Non-Opening Cavity Access:** designs require cables or hoses to be fished through center cavity or carrier system. This type of carrier system consists of simple molded links available in a wide range of widths that can be snapped together to easily create customized system lengths.

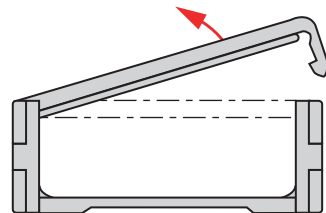

**2. Opening Cavity Access:** design has snap-open bars or lids for cables or hoses to be easily "dropped" into carrier cavity. This type of carrier system consists of simple molded links available in a wide range of widths that can be snapped together to easily create customized system lengths.



The proper carrier family size needs to be selected, once one of the two aforementioned designs has been selected which has a cavity size available that best suits the inner height (**h<sub>i</sub>**) and width (**B<sub>i</sub>**) requirements calculated above.

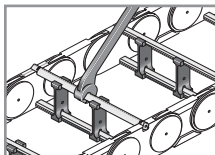

**b.) Modular Design:** Carrier systems consisting of molded polymer, aluminum, and plated steel with countless design options available through assembled components.

■ Please note the KS system product group (type and style), design (mono or modular) and size.

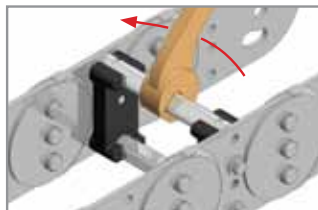

**1. Hinged or Twist Opening Access to Cavities:** design has snap-open bars or lids that are hinged as well as twist in and out (90 degrees, with open ended wrench) for cables or hoses to be easily "dropped" into carrier cavity.

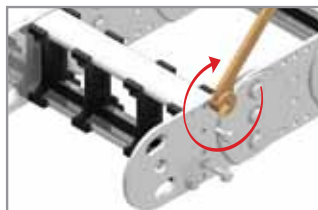

**2. Bolted-on/off Bar Access to Cavities:** designs have bolted-on (can be easily disassembled by simply unbolting parts) reinforced aluminum bars for incredible strength and design flexibility (size, configuration, etc.)



The proper carrier family size needs to be selected, once one of the two modular aforementioned designs has been selected, which has a cavity size available that best suits the inner height (**h<sub>i</sub>**) and width (**B<sub>i</sub>**) requirements calculated above.

#### 5.) Basic selection criteria: Cavity Size

Once the best product type and style has been selected, find the proper cavity size available within that group type and style that best accepts the calculated inner cavity width (**B<sub>i</sub>**) and height (**h<sub>i</sub>**) values including all applicable safety factors.

■ Please note the KabelSchlepp system product group, type and style.



## Step 3 Select The Proper Carrier Bend Radius (KR) & Mounting Height (H)

**1.) Determining the Bend Radius (KR):** To determine the correct carrier system bend radius (KR), use the largest cable or hose in your particular application and multiply the most appropriate KabelSchlepp standard bend (KR) radius safety factor as listed below:

When possible, using the cable or hose manufacturer's published specifications. However, when this information is unavailable, consider the following rules of thumb:



for **continuous hi-flex-cables** use **7.5 x** the cable outside diameter as a minimum



for standard **continuous flex-cables** use **10 x** the cable outside diameter as a minimum



for **continuous flex-hoses with their contents at less than 1000 psi**, use **10 x** the hose outside diameter as a minimum



for **continuous flex-hoses with their contents at greater than 1000 psi**, use **12 x** the hose outside diameter as a minimum

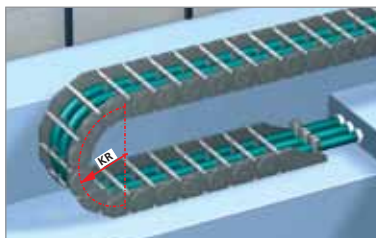

**2.) Minimum Bend Radius:** To determine the minimum bend radius (KR) of a carrier system, use and select the closest available bend radius size option (catalog example: Option A, B, or C etc.) that properly accepts the minimum bending requirements calculated (step 3, number 1 above) of the largest cable and/or hose from within the selected carrier product category, design, and size in the KabelSchlepp catalog.

a.) If this list of bend radii (KR) size options is too small, move to the next larger carrier size within the product group and type you have selected and select the best bend radius option available there.

b.) Always allow 10% (1.10 multiplier) operating space above the carrier system loop (H<sub>Z</sub>) for the inherent "crown" or pre-tension.



$$H_Z = H \times 1.10$$

c.) Make note of the bend radius (KR) option that best fits your application requirements.

cable carrier may have inherent crown/pre-tension (H<sub>Z</sub>)

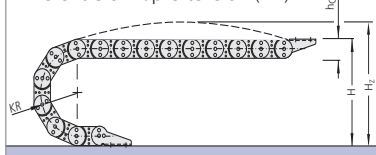

### GENERAL DATA

<b>E</b>	<b>CONOMIC</b>
<b>V</b>	<b>ALUE</b>
<b>A</b>	<b>DDED</b>
<b>3</b>	

A product group's EVA score is a general indicator that allows a customer to quickly and easily compare a product group's basic price, features, capabilities and value relative to other comparably sized products within the KS product range.

Download 3D CAD files, videos, updated product info & much more at:  
[www.kabelschlepp.com/plasttrak.htm](http://www.kabelschlepp.com/plasttrak.htm)

Dimensions in inches (mm)

### Technical Data

Series	Mounting Height H	Bend Radius KR	Depot U <sub>B</sub>	Loop Length L <sub>B</sub>
0320				
Option A	3.90 (99)	1.46 (37)	3.23 (82)	7.13 (181)
Option B	4.69 (119)	1.85 (47)	3.62 (92)	8.35 (212)
Option C	7.05 (179)	3.03 (77)	4.80 (122)	12.05 (306)
Option D*	8.86 (225)	3.94 (100)	5.71 (145)	14.92 (379)

\* KR 100 - special order

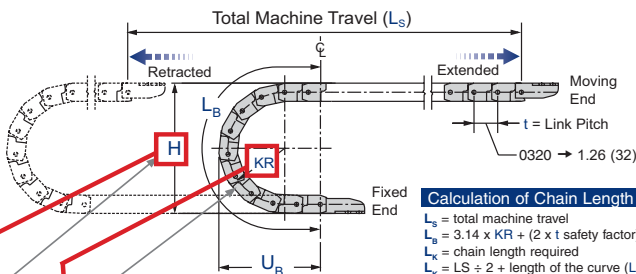

### Calculation of Chain Length

L<sub>s</sub> = total machine travel  
 L<sub>B</sub> = 3.14 x KR + (2 x t safety factor)  
 L<sub>x</sub> = chain length required  
 L<sub>x</sub> = L<sub>s</sub> ÷ 2 + length of the curve (L<sub>B</sub>)\*  
 \* Assumes the Fixed Point is located at the Center of the Total Machine Travel.



### Increasing Cable/Hose Life

When selecting a cable carrier system, always choose a cable carrier that has a **minimum** bend radius (KR) that is equal to or larger than the manufacturer's recommended minimum continuously-flexing bend radius of any of the cables or hoses used in the carrier. Typically, increasing the bend radius of the carrier system will reduce the amount of bending stress that is put on cables and hoses resulting in longer operational life. Therefore, it is recommended to use the largest cable carrier bend radius option that will still fit within your operating envelope.

**Larger KR = Longer Life**

### Self-Supporting Lengths

lbs	kg
ft	m



## Step 4 Summarize And Double Check

At this step, you should now have selected and noted the:

1. Carrier product group (system type, style and link size)
2. Carrier cavity size (cavity inner height  $h_i$  and width  $B_i$ )
3. Carrier bend radius option (the best  $KR$  option of those offered for your application)

Once you have double checked your selections, you can then move on to calculate the correct carrier system length  $L_k$  that your application or machine requires.

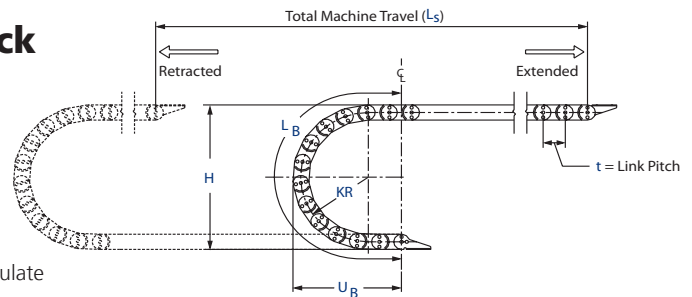

## Step 5 Determine The Carrier System Loop Length (LB)

To determine the total chain length needed for your cable carrier system in Step 6, you will first need to calculate the carrier's Loop Length ( $L_B$ ). The Loop Length ( $L_B$ ) dimensions can typically be found listed in the Technical Data section of each product section in the KabelSchlepp Catalog. To calculate the recommended Loop Length ( $L_B$ ) yourself, use the formulas listed in the table to the right.

### Calculating Carrier System Loop Length ( $L_B$ )



Plastic cable carriers:  $L_B = (3.14 \times KR) + (2 \times t)$

Steel cable carriers:  $L_B = (3.14 \times KR) + (4 \times t)$

QUANTUM cable carriers:  $L_B = (3.14 \times KR) + (12 \times t)$

PROFILE, CONDUFLEX cable carriers:  $L_B = (3.14 \times KR) + (9 \times t)$

## Step 6 Calculate The Total Carrier System Length ( $L_k$ )

To determine the most economical length of a KabelSchlepp carrier system, in all horizontal or vertical carrier system operating modes, use one of the first 3 formulas listed below to solve for the required carrier length ( $L_k$ ) and number 4 to solve for the number of links ( $t$ ) needed.

**ME = Moving End of carrier system**

**FE = Fixed End of carrier system**

**FP = Fixed Point of carrier system**

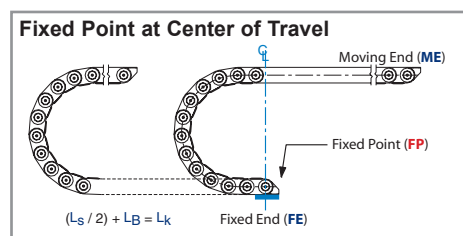

### 1.) FIXED POINT AT CENTER OF TRAVEL

For a carrier system that has its fixed point located centrally relative to the total machine travel use:



$$\frac{L_S}{2} + L_B = L_k$$

The total travel ( $L_S$ ) divided by 2  
+ the carrier loop length ( $L_B$  as defined in catalog)  
= The Required Carrier Length ( $L_k$ )

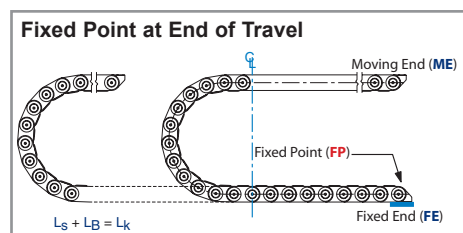

### 2.) FIXED POINT AT END OF TRAVEL

For a carrier system that has its Fixed End located at either the extended or retracted [far] end of total machine travel use:



$$L_S + L_B = L_k$$

The total travel ( $L_S$ )  
+ the carrier loop length ( $L_B$  as defined in catalog)  
= The Required Carrier Length ( $L_k$ )

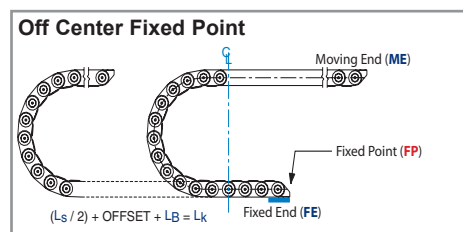

### 3.) FIXED END OFF CENTER OF TRAVEL

For a carrier system that has its fixed point located somewhere not central to, or at either end of the total machine travel use:



$$\frac{L_S}{2} + \text{OFF}_{\text{CMT}} + L_B = L_k$$

The total travel ( ) + the offset from the center of the machine travel ( ) + the carrier loop length ( )  
= The Required Carrier Length ( )



## Step 6 Calculate The Total Carrier System Length ( $L_k$ ) (continued)

- 4.) Once the carrier system length ( $L_k$ ) is determined, this length must be divided by the selected carrier type link pitch ( $t$ ) to calculate the correct number of links to be used and ordered. **Always round up to the nearest link!**



$$(L_k \div t) = \sum t$$

**Note:** Always remember to divide the required length ( $L_k$ ) by the selected KabelSchlepp carrier system pitch ( $t$ ), rounded up to the nearest link, to get the correct ( $\sum t$ ) total number of links the system requires.

- 5.) If a system with circular travel action or a multi-axis (movement in the X+Y, X+Z, etc.) travel action is required, please consult the factory with the following information:

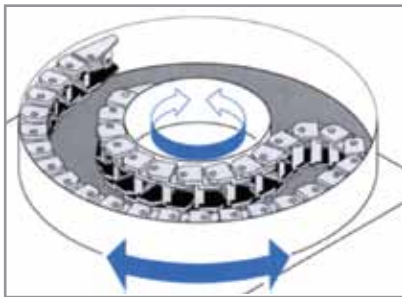

- a.) for a **circular travel system** (typically tipped onto its side), please define (see page 2.26):

- the center fixed point of total travel action
- the total degrees of rotation
- start and stop points to the aforementioned rotation
- the moving end location (rotates along the I.D. or O.D. of the system)
- the minimum inner operating diameter dimension
- the maximum outer operating diameter dimension

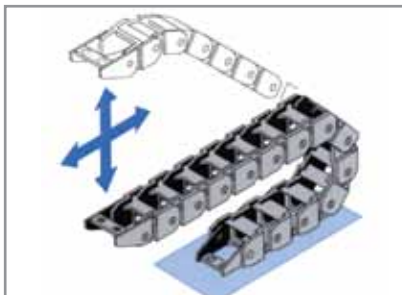

- b.) for a **multi-axis travel system**, please define:

- the center fixed point of total travel action
- total distance and direction of travel, from the fixed point location, in one (example "X") axis of travel
- the total distance and direction of travel, from the fixed point location, in another (example "Y") axis of travel
- the total distance and direction of travel, from the fixed point location, in another (example "Z") axis of travel

## Step 7 Select Bracket Style And Mounting Position

Finally, always remember to include the correct [product group] carrier system mounting brackets.

- a.) Identify one of the following mounting styles and positions desired:

i.) **Style:** Universal, 2 piece, 4 piece, and flange are some of the common options. Availability is dependent upon carrier type and size. Special order custom brackets can also be provided if needed.

ii.) **Position:** Position options vary and will be dependent upon the bracket style selected.

### Examples of Common Bracket Types



Standard left and right hand brackets



Universal style brackets without strain relief

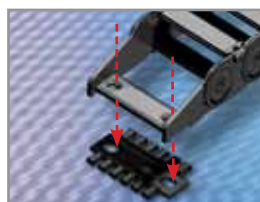

Standard bracket with snap-on strain relief



Standard bracket with integral strain relief



Standard bracket without strain relief

### Step 7 Select Bracket Style And Mounting Position (continued)

#### 2 Piece Standard Mounting Bracket

##### Standard 2 Piece Mounting Brackets

Commonly used on mono molded link type carrier systems, KabelSchlepp 2 piece mounting brackets are commonly offered with or without integral strain relief. In some cases, the optional strain relief piece can be detached from the bracket and mounted separately for additional installation options. Brackets are made of nylon, hybrid nylon & aluminum, or steel dependent upon size and type of carrier system.



##### UMB (Universal Mounting Brackets)

Because UMB brackets can be attached to the mounting surface from above, below or at the front of the bracket, they allow a great deal of installation options from a single bracket type. Dependent upon size and type of carrier, these brackets are made of reinforced nylon (smaller sizes) or cast aluminum (larger sizes).



#### 4 Piece Standard Mounting Bracket

##### Standard 4 Piece Mounting Brackets

Offered on a wide range of KabelSchlepp carrier systems, 4 piece standard brackets offer a wide range of possible mounting positions. 4 piece brackets are typically made of high strength stamped steel.

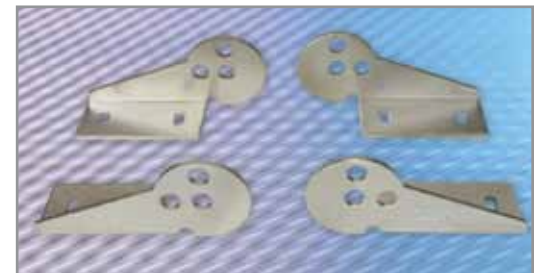

#### Specifying Mounting Position

Most KabelSchlepp mounting brackets can be installed in multiple different positions dependent upon the application. See each product's individual mounting bracket pages for available options. A sample mounting bracket configuration is shown below:

##### Bracket End

- M - Moving End
- F - Fixed End

##### Bracket Position

- A - connecting surface on outside radius (standard)
- I - connecting surface on inside radius
- H - connecting surface turned 90° to the outside radius
- K - connecting surface turned 90° to the inside radius
- U - Universal Bracket (not pictured, see opposite page)

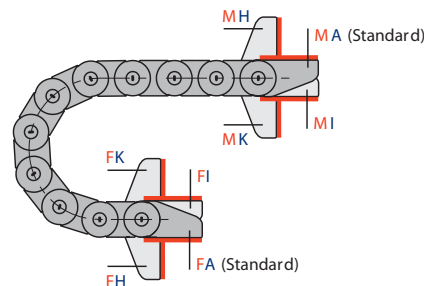

Please specify the desired bracket variant and position when ordering.

**Example:** FA/MAI (Standard) or FAA/MIA

The bracket positions at the Fixed End and Moving End can be changed later if required.

##### For 4 pc brackets with positionable feet:

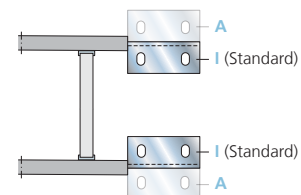

Bracket feet on the standard 4 pc brackets can be positioned facing inward (I) which is the standard position or facing outward (A)



## DESIGN CONSIDERATIONS - Section 1

## Carrier Frame Stay System Options

The numerous frame stay configurations explained below offer the designing engineer a wide range of options suitable for almost any application requirement. Custom designed options specifically designed to suit your unique application can be developed by our engineering department. For custom designs or assistance, please contact KabelSchlepp's technical office: **1-800-443-4216** or [www.kabelschlepp.com](http://www.kabelschlepp.com).



### Type: MONO

Mono type frame stays are molded at fixed widths and typically come in non-opening and opening versions, dependent upon the size and series of the cable carrier. Systems with a mono type frame stay tend to be less expensive and have less configuration options than comparably sized systems using modular frame stays.



### Type: RE

Standard open style system - installation uses twist in/out bars - selected for its ease to access the carrier system cavity. Can be ordered in 8 mm (smaller sizes) and 16 mm (larger sizes) custom width increments. Smooth fiber reinforced molded polymer bars.



### Type: RS

Standard open style system - installation uses two twist in/out aluminum bars - selected for its ease to access the carrier system cavity. Any custom cavity width can be ordered. Smooth cable/hose friendly extruded light weight aluminum bars.



### Type: RS 1

Standard open style system - installation uses twist in/out aluminum bars on the outside radius and bolted-in aluminum bars on the inside radius - selected for its ease to access the carrier system cavity. Any custom cavity width can be ordered. Smooth cable/hose friendly extruded light weight aluminum bars.



### Type: RS 2

Standard open style system - installation uses two bolts per bar - selected for its strength and ease by which the carrier system cavity can be accessed by removing the bolted-in bars. Any custom cavity width can be ordered. Smooth cable/hose friendly extruded light weight aluminum bars.



### Type: RV

Standard open style system - installation uses twist in/out reinforced bars - selected for its added strength and extreme ease to access the carrier system cavity. Can be ordered in any custom cavity width. Smooth cable/hose friendly reinforced extruded aluminum bars.



### Type: RMS

Standard open style system - typical installation uses four bolts per bar - selected for its super-duty strength and rigidity and ideal for extra wide and heavy carrier systems. Carrier system cavity can be easily accessed. Any custom width can be ordered. Smooth and wide cable and hose friendly extruded aluminum bars for superior protection against cable/hose wear.



### Type: RMR

Standard open style system - installation uses four bolts per bar - selected for its strength, rigidity and best-in-industry cable/hose friendliness. Any width can be ordered. Smooth and durable cable/hose friendly extruded aluminum bars available with free-rolling integral Delrin® support and dividing systems for ultimate protection against cable/hose wear.

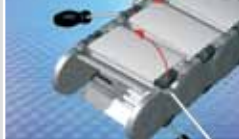

### Type: RMD/RDD

Standard enclosed cavity system - installation uses four bolts (RMD) or snap-on lids (RDD) - expressly designed for applications requiring protection against debris. Available in fiber reinforced molded polymer (RDD) or smooth high strength extruded aluminum materials (RMD). RMD's aluminum lids can be ordered in custom specified widths. MT's nylon lids are available in standard width increments of 8 mm (smaller sizes) or 16 mm (larger sizes). RMD aluminum lids are suitable for protection against red-hot debris.



### Type: RMA

Custom open cavity extender system - installation uses four bolts and twist in/out bars - specifically designed for applications in which large diameter hoses need to be carefully guided. Any custom width can be ordered. Smooth cable/hose friendly extruded aluminum bars and high strength polymer extender bars. This system can only glide on itself when extender bars are attached to the outer radius together with an open bottom style guide channel.



### Type: LG

Custom open hole style system - installation uses four bolts per bar - selected for its super-duty strength, rigidity and precise separation and placement of all cables/hoses on the carrier system's neutral axis (where the cable/hose relative movement is minimized). Cables and hoses can be easily accessed for maintenance. Any custom width, hole size and shape can be ordered.

**DESIGN CONSIDERATIONS - Section 2 Cable & Hose Strain Relief Systems**

To dramatically increase cable, hose as well as carrier system performance and longevity, proper cable and hose strain reliefs at both ends of the carrier system are required. KabelSchlepp offers a wide variety of effective cable & hose clamping systems, examples of which are shown below.

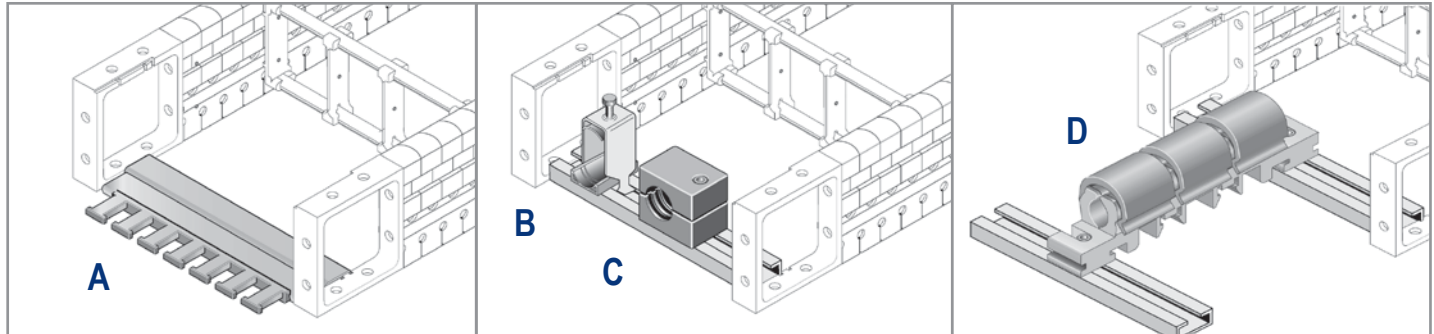

**A Tie-wrap style** - "Comb" style plates

**B Saddle style** - Screw-down modular clamps  
**C Block style** - Screw-down split block clamps

**D SZL style** - Snap or Screw-down clamps

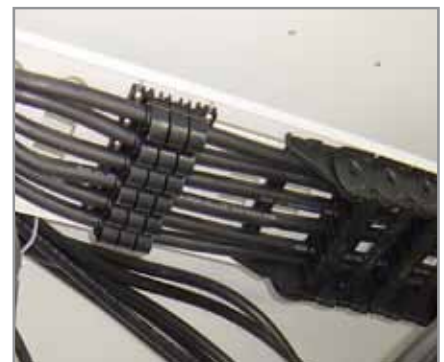



## Know Your Cables & Their Specs

The following information should be used together with other explanations and design recommendations in this Handbook.



An example of corkscrewing where cables twist themselves.

### Cables that have failed typically show the following symptoms:

- corkscrewing where cables twist in themselves
- knotting of conductors underneath the cable jacket
- cables twist around one another within a cable carrier system
- cables are sticking out between the cable carrier crossbars and getting caught in the bend radius
- cables entangled with other cables and crossbars tearing them apart
- loss of conductivity through simple breaking of cable conductors



Cable failure showing entangled cables and ruptured jacket.

### Common causes of cable failure when operating in a cable carrier system:

- cables used are not designed for use in continuous flexing operation
- cables are packed too tight inside the cable carrier cavities
- the actual operating bend radius of the application is smaller than the minimum bend radius recommended by the cable manufacturer
- cable carrier design is not cable friendly or optimal for the types of cables being used

### Proper Unspooling Of Cables And Hoses

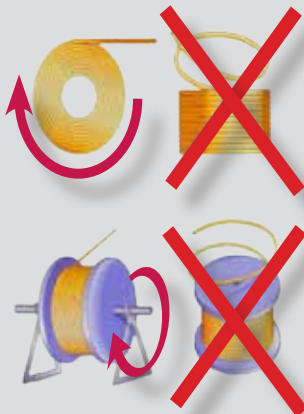

When installing cables or hoses into a carrier system, they should be laid into the carrier without twist and in accordance to the guidelines outlined in this Technical Handbook. Cables or hoses should not be simply pulled off the top of a reel. Instead, they should be properly uncoiled from a reel as shown in the illustration above.

All too often those more commonly selected or used industrial cables are not designed for continuous flexing or bending operation as seen in cable carrier systems. They will quickly cork-screw and knot, especially when run within a tight cable carrier bend radius. Also, many standard industrial cables require a bend radius larger than most machinery applications allow and as a result, force these cables to run at a tighter than recommended radius. This will undoubtedly substantially reduce cable life. A cable specifically designed for continually-flexing tight bending radii must be selected.

Some commonly used cables also use a cotton tape between the inner conductors and the outer jacket. Due to the constant bending when operating within a cable carrier system this cotton tape will often bunch up underneath the jacket and crimp the conductors causing premature cable failure.

Cables with a built-in twist will develop a cork-screw effect more easily. Additionally, this inherent twist is further amplified by the constant flexing and relative-movement of the cable operating in a cable carrier until the cable conductors break.

The best choice for a cable to be used in a cable carrier should be PVC/PUR/TPE/TPM jacketed. **Cable jackets made of rubber or neoprene are generally not recommended.** The latter two materials are too sticky and do not allow the cables to move easily relative to one another and the cable carrier. This will also contribute to the aforementioned cable knotting.

Cables designed for use in continuous motion applications using cable carrier must be manufactured on a unique cabling machine that will minimize any back-twist on the cable core.

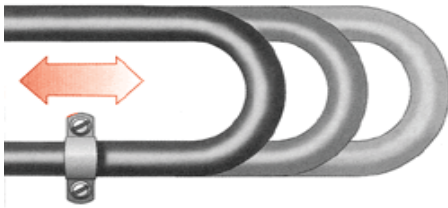

**Continuous Flex** – In such cases the cable is rolling back and forth in a linear motion resulting in the cable (and conductors within) to flex in an equivalent way. This is typically the case for all cables that are approved for use within cable carrier systems where required bend radii are typically 10x the cable O.D. or less.

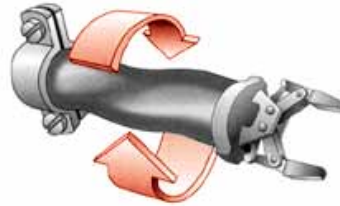

**Torsional Flex** – In such cases, the cable is being twisted clockwise and counterclockwise off its center-line axis with angles varying from 90 to 360 degrees “rotation”. This type of flexing typically occurs on multi-axis robotic machinery that requires constant twisting and flexing over a sustained period of time.

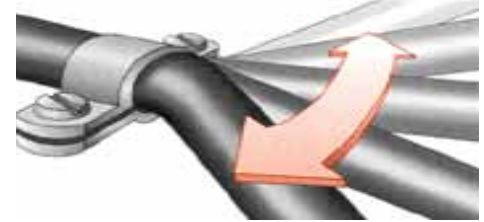

**Bending Flex** – In such cases, the cable is flexing back and forth off a stationary point. Industry commonly refers to this as a tick-tock motion. A vast majority of the stress on the cable in such a case are the two focal points where the bend and load are being applied.

## GENERAL APPLICATION RANGE OF FLEXIBLE CABLES



FIELD INSTALLATION	LIMP CABLE	CASUAL FLEX	CONTINUOUS HI-FLEX*
Building	Extension Cords	Power Cords	Gantry Robots
Coaxial	Welding Cable		Pick & Place Machinery
Communication	Stage Lighting		Automated Machinery
Instrumentation	Sound Cable		Machine Tools

\* Cables that are considered to be **continuous hi-flex** are typically the best choice for use in dynamic cable carrier systems.

## Understanding Cabling Techniques

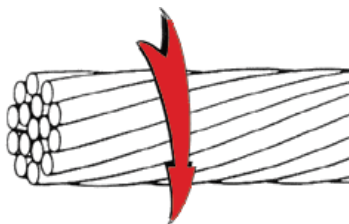

**Unilay or Bunch** – In such cables conductors (copper groups or bunches of wire strands) of any number are twisted together with the same lay direction and cable lay length. Bunch construction will not have a well defined geometric configuration and may have a variable cross-section. A Unilay construction will have a well defined geometric configuration and a defined cross-section. This type of cabling technique is usually used in static applications and designs.

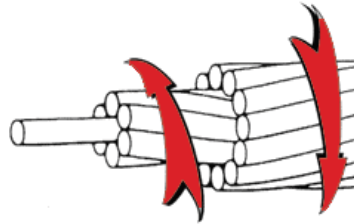

**Concentric Contra-Helical** – In such cables conductors are surrounded by well defined layers of helically laid conductors. Each layer has a reversed lay direction and an increasing lay length in each succeeding layer. This type of cabling technique is usually used on continuous flex cable applications and designs (that should be used in cable carriers).

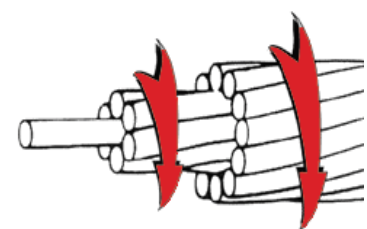

**Concentric Unilay** – In such cases conductors are surrounded by one or more layers of helically laid conductors with the same direction or lay and increasing lay length in each succeeding layer. This type of cabling technique is usually used in torsional flex applications and designs.



## DESIGN CONSIDERATIONS - Section 4 Common Carrier Operating Modes

The following carrier system orientation photos show some of the most common ways that cable and hose carriers are applied in the real world. Contact the KabelSchlepp factory for assistance if your application requires an orientation not shown.

**Horizontal**  
"self-supporting"

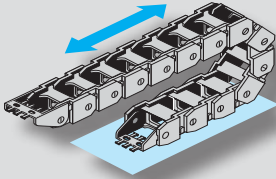

**Horizontal**  
"with permissible sag"

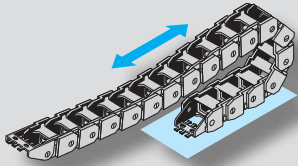

**Horizontal Supported**  
"w/ support rollers or tray"

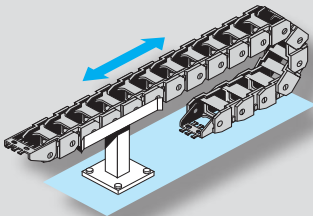

**Horizontal**  
"gliding in guide channel"

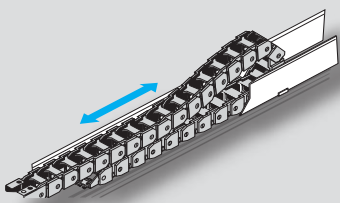

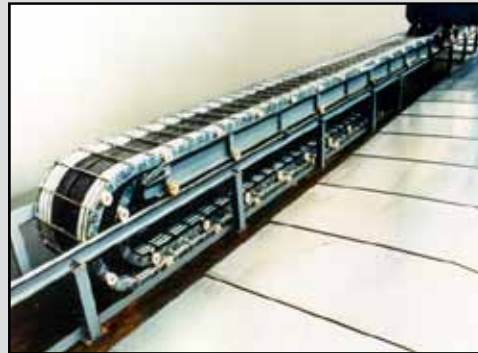
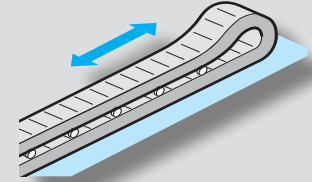
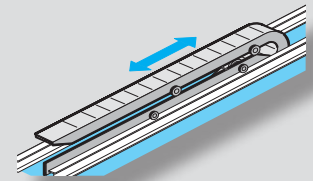
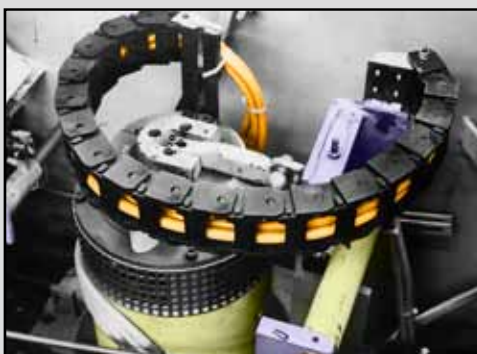
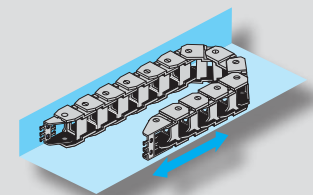
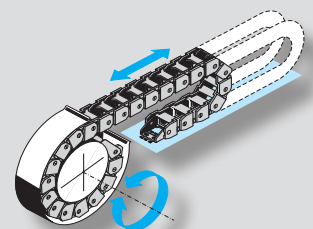

**Horizontal  
Long Travel**  
"using KabelSkate"**Horizontal  
Long Travel**  
"w/ rolling carriage system"**Side Mount****Rotary**



(continued)

### Circular

"with reverse bend radius in guide channel"

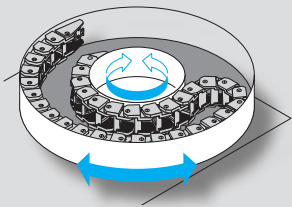

### Vertical - Standing

"loop on top"

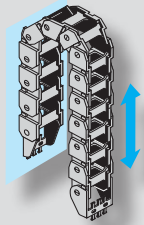

### Vertical - Hanging

"loop on bottom"

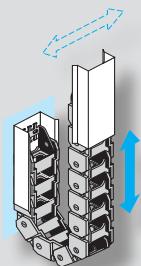

### 3 Dimensional

"multi-axis movement"

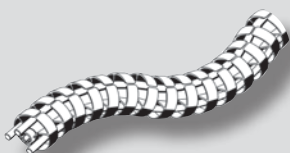

**Two Axis**

"vertical and horizontal"

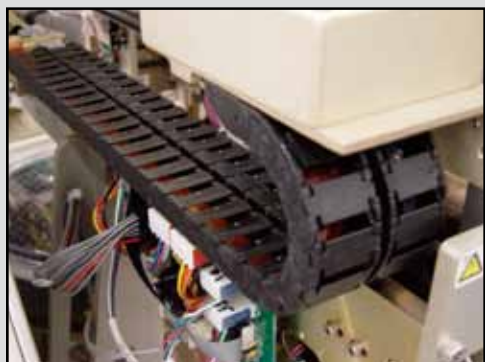
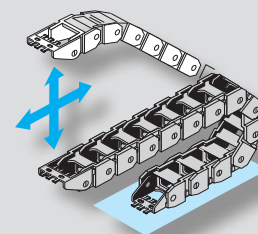

"multiple chain system"

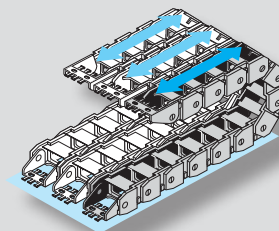
**Nested**

"multiple chain system"

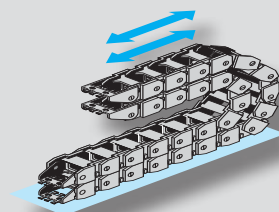

"multiple chain system"

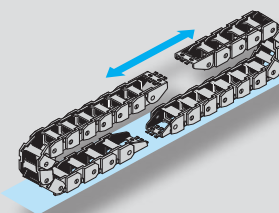



## DESIGN CONSIDERATIONS - Section 5 Material Properties

### Properties Of Nylon Cable Carrier Systems In Different Environmental Conditions



#### Environment



KS has materials suitable for harsh or extreme indoor as well as outdoor applications.

**Standard Polymer Operating Temperature Range:**  
**-40° F (-40° C) to 266° F (130° C)**

It is recommended to use our special hot or cold temperature materials or our steel chain systems, when sustained operating temperatures remain below -13° F (-25° C) or above 185° F (85° C). Once either of these levels is eclipsed, the mechanical values are reduced and service life degraded. Please consult KabelSchlepp for a suitable solution. Chemical, flame, debris, UV and temperature resistant materials are readily available whenever required.



#### Vacuum

Nylon cable carriers can also be used in vacuums. In the case of intermittent loads the traction forces occurring should be ascertained.

**Please consult our factory in every such case.**

#### Resistance to Radiation



With a dose of up to **1 megarad** the material does not deteriorate. When the dose is increased to 100 megarads the material becomes steadily more brittle. The maximum limits of the mechanical properties drop by 30% at 100 megarad. Where the dose **exceeds 100 megarad**, the use of nylon cable carriers is not recommended.

**Please consult our factory in these cases.**



#### Flammability

According to the testing process in line with VDE 0304 Part 3 (05.70) the standard material (KS-PA, reinforced with glass fiber) corresponds to classification II c.

Tested in line with UL 94 - ASTM 0635-81  
 Classification: "UL 94-HB"

Tested in line with DIN 4102, "Burning characteristics of construction materials and component parts"

Classification: Construction material class B2, minimum thickness < 1 mm, not dropping if burning.

#### Resistant to cold storage



For plastic cable carriers able to withstand cold storage areas, a special material is used. These cable carriers can only be produced in yellowish/white (transparent).



#### Ex-protected cable carriers

Cable carriers for use in areas at risk of explosion or static discharge resistant, are produced from a **special material** and are only available in black. Since there is nothing to differentiate them by sight from standard cable carriers, these cable carriers are identified with a stamp marked "EX".

- Flash point of special material: 536° F (280° C)
- Ignition temperature of special material: 779° F (415° C)
- Surface resistance: <math> < 10^5 \Omega </math> (Standard Material min.  $10^{10} \Omega$ )
- Volume resistance: <math> < 10^5 \Omega \times \text{cm} </math> (Standard Material min.  $10^{12} \Omega \times \text{cm}$ )

**Properties Of Steel Cable Carrier Systems In Different Environmental Conditions**

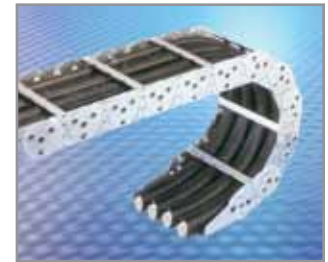

**Temperature**

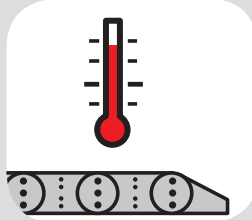

Cable carrier systems may be applied in the following temperature ranges dependent on the frame stay option selected.

Frame Stay Variant	Temperature Range
Frame stays with nylon parts	- 40° F (- 40° C) to 266° F (130 °C)
Bolted aluminum frame stays	-13° F (- 25° C) to 482° F (250 °C)
Bolted bar stays (complete steel system)	- 40° F (- 40° C) to 752° F(400 °C)

**Note:** Take care in using a suitable cable or hose.

**Note:** Please also consider the allowable temperature ranges for cable installations.

**Chemical Resistance**



KabelSchlepp cable carrier systems with side-bands made of steel are resistant to a wide variety of chemical influences.

**Note:** Please note that cable carriers made of galvanized steel are not acid resistant. For applications in an aggressive environment, we recommend rust and acid resistant stainless steel cable carriers.

**Dust and Particulates**

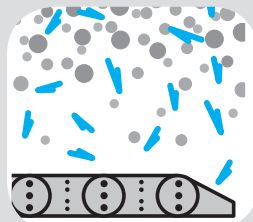

To protect your cables and hoses against dust and particulates or other mechanical influences, we offer you our cable carrier systems with stainless steel chip covers or easily serviceable aluminum lids.

- Stainless steel chip covers - contact factory
- Frame stays with aluminum lids - frame stay variant RMD

**Humidity & UV Influences**



Steel cable carrier systems are protected against corrosion and may be applied in humid rooms or in outdoor environments. Stainless steels for green sea environments and the food industry are also available. The nylon material used in some frame stays is UV resistant!

**Electrostatic Discharge Protection**



Cable carrier systems with steel chains are conductive and have an electrostatic discharge. Thus, they are suitable in explosion-hazardous environments.

**Note:** Steel cable carriers must be grounded at the mounting brackets.



## Nylon Polymer Material Specifications & Details



**Standard Color:** Black is the standard color. Molded plastic cable and hose carriers can be supplied in other colors.  
**Standard Material:** 35% Glass fiber reinforced Nylon 6 resin.

Molded plastic cable and hose carriers can be supplied in other colors including red, green, blue, yellow, orange and many more. Please remember to always provide correct PMS color code(s) for special color(s). — *Special Order Only!* Molded plastic cable and hose carriers for application in the range of radioactive radiation or for permanent temperatures below -40° F (40° C) require special additives and can also be supplied by KabelSchlepp. The plastic used is free of halogens, silicon and heavy metals such as lead and cadmium. No formaldehydes are used in the manufacturing process. Plastic components meet food industry standards and can be used without restriction. Please give us detailed information on your environment conditions. All nylon chains are also available in flame retardant materials of various colors. — *Special Order!*

### Admissible Operating Temperatures

Standard Operation: **-40°F (-40° C) to 266° F (130° C)** for short term operation: **392° F (200° C)**

Chain side bands reinforced for high strength, stiffness, straightness, and performance at elevated temperatures.

TEST	UNITS		TEST METHOD	REINFORCED NYLON 6	
	ENGLISH	(METRIC)		ENGLISH	(METRIC)
<b>Key mechanical properties</b>					
Tensile strength at yield	PSI	(MPa)	D-638	28,500	(197)
Ultimate elongation	%		D-368	3	
Flexural strength	PSI	(MPa)	D-790	40,500	(279)
Flexural modulus	PSI	(MPa)	D-790	1,500,000	(8,966)
Notched izod impact strength	ft. lbs. /inch	(J/m)	D-256	3.4	(183)
Heat deflection temp. @ 264 PSI	°F	(°C)	D-648	419	(215)
Rockwell hardness (M scale)			D-785	104	
Shrinkage (1/8" bar)	in./in.			0015	
<b>General physical properties</b>					
Specific gravity			D-792	1.41	
Melting point	°F	(°C)	D-789	428	(220)
Equilibrium moisture content @ 50% RH	%			2.0	
Saturation moisture	%			6.2	
Coefficient of linear thermal expansion	$\frac{\text{in.}}{\text{in.}} \text{ } ^\circ\text{F}$	$\frac{(\text{mm})}{(\text{mm})} \text{ } ^\circ\text{C}$	D-696	$\frac{1.0 \times 10^{-5}}{3.6 \times 10^{-5}}$	$\frac{(1.8 \times 10^{-5})}{(6.5 \times 10^{-5})}$
Flammability (1/16" bar)			UL-94	94 HB	

### Chemical resistivity of the standard KabelSchlepp nylon material.

(The data listed below was developed in actual laboratory tests (factory certified). Please contact us for all materials not shown in this table.)

Against	Resistance	Against	Resistance	Against	Resistance
Acetic Acid	■	Formaldehyde and Polymac.	●	Oleic Acid	●
Acetone	●	Formic Acid	●	Paint & Lacquers	●
Ammonia	■	Greases and Waxes	●	Paraffin, Paraffin Oil	●
Benzine, Benzole	●	Hydraulic Oils	●	Polyester Resins	●
Bitumen	●	Hydrochloric Acid (aqueous)	■	Potassium Hydroxide	●
Boric Acid (aqueous)	●	Lactic Acid (aqueous)	●	Potassium Chloride (aqueous)	●
Butyric Acid	●	Lactic Acid	▲	Potassium Nitrate (aqueous)	●
Calcium Chloride (aqueous)	●	Liquid petrol gas. (DIN 51622)	●	Propane Gas, Propyl. Hydride	●
Chlorine, Chlorinated Water	■	Lubricants, Edible Fats	●	Sodium Carbonate (aqueous)	●
Chromic Acid (aqueous)	▲	Mercury	●	Tartaric Acid	■
Diesel Oil	●	Methyl Acetate	●	Tartaric Acid (aqueous)	●
Ethanol	●	Milk	●	Vaseline	●
Ethyl Acetate	●	Mineral Oil	●	Xylene	●
Fluorinated Hydrocarbons	●	Oil - Edible and Lubricating	●		

● = Resistant    ■ = Conditionally Resistant    ▲ = Not Resistant

## Steel Material Specifications & Details

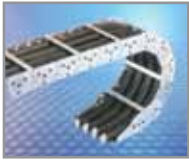

The specific type of steel material used in KabelSchlepp Varitrac S cable and hose carrier side-bands and various system brackets and accessories, is dependent upon the systems' or accessories' intended application and operating environment. The standard design material is zinc-plated steel which can be used for standard loads. For higher loads, steel can be chrome-plated, nitrogen hardened, etc. In the case of non-standard/custom applications, high-grade stainless steel options are available.

Chain Band Material	Galvanized Zinc-Plated Steel	Stainless Steel	High Grade Stainless Steel
Chemical Resistance	Limited	Good	Best
Applications		Particularly suitable for chemical manufacturing machinery and the food industry.	Particularly resistant to stress cracking, corrosion and pitting even when exposed to chlorine. Also resistant to intercrystalline corrosion when welded.
Weather Resistance	Good	Very Good	Best
Mechanical Specifications	Wear-resistant	Wear-resistant	Particularly wear resistant, good mechanical properties.
Typical/Preferred Areas of Application	General machine building industry, welding and punching machines, steel works and rolling mills, automotive industry, conveyor systems, etc.	Special machinery, utility equipment, chemical refineries.	Food and dairy industries, breweries, chemical and petro-chemical industries, nuclear technology, salt/sea water.

## Aluminum Material Specifications & Details



Aluminum alloy is commonly used on various KabelSchlepp frame stays, brackets, and accessories due to its inherent favorable mechanical, physical and chemical properties for a wide range of applications.

### Characteristics that make aluminum alloy the material of choice on modular frame stay systems:

- Light weight, strong, hard, stiff, smooth
- Holds up well to environmental factors
- Holds up well to temperature extremes
- Modern and aesthetically pleasing design
- Optimal friction and wear characteristics

### Aluminum Material Technical Data:

Density	2.7 g / cm <sup>3</sup>
Elasticity	70 kN / mm <sup>2</sup>
Electrical conductivity	28 - 34 m / W mm <sup>2</sup>
Thermal conductivity	1.9 -2.1 W/k • cm
Heat expansion coefficient	23.4 cm / cm k 10 <sup>6</sup>
Strength	215 N / mm <sup>2</sup>
Elongation after fracture	12%

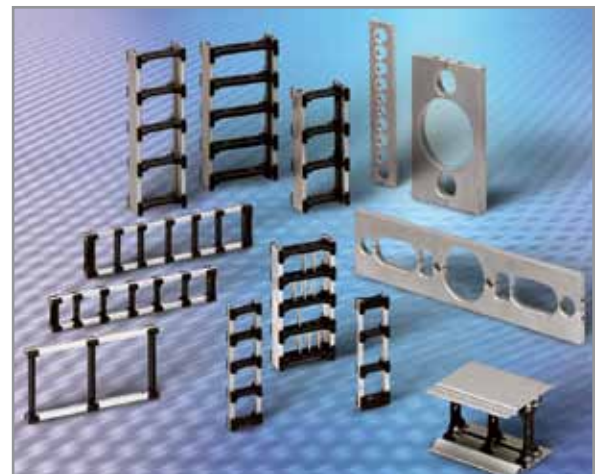



## Frame Stay Bar Cable Abrasion

Selecting the correct frame stay bar system plays a significant role in determining the cycle life of cables and hoses placed inside the system. The following table details comparison results from extensive testing done to determine the effects that the frame stay bar systems have on cable jacket wear.

### ABRASIVE CHARACTERISTICS OF CABLES

Depending upon cable sheath and frame stay materials.

### QUALIFIER:

Data listed are results from an abrasion test— After 3 million cycles and a 10 mm relative movement between carrier frame stay and cable.

### CABLE SHEATH MATERIAL:

- PVC — Polyvinyl chloride
- PUR — Polyurethane
- PETP — Polyethylenterephthalat

### CONCLUSION:

Long-term evaluation tests on cables with different sheath materials have conclusively answered the question regarding optimal stay material and design configuration for the most common sheath materials. KabelSchlepp offers numerous different frame stay types and materials so the customer can correctly address design, function and commercial considerations as they relate to each of the customer's specific applications.

When selecting cables, also carefully consider the abrasive characteristics of the cable sheath material in conjunction with the material and type of frame stay.

Without question, frame stay designs using aluminum alloy material supporting the cables have distinguished themselves as the "most cable friendly" designs.

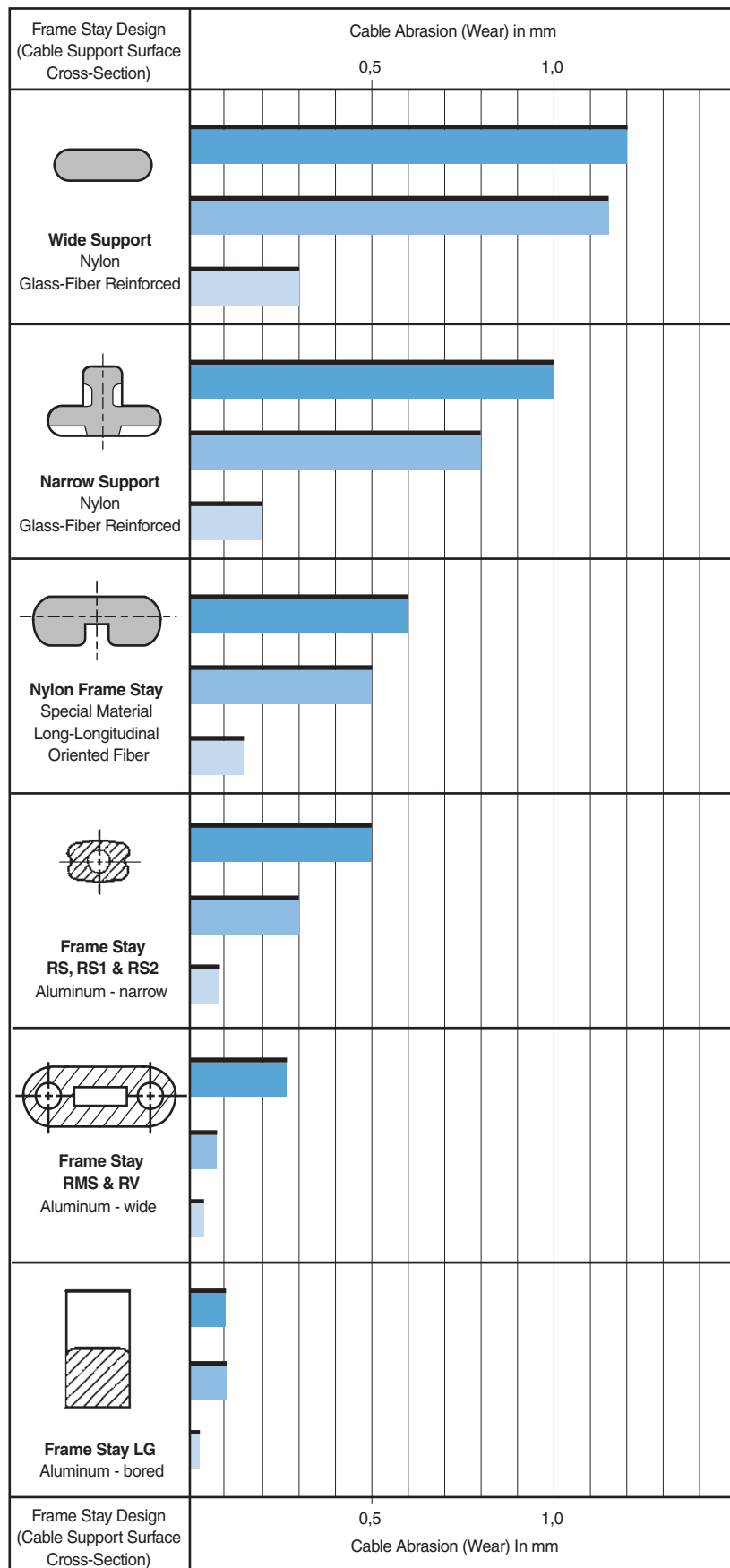



### DESIGN CONSIDERATIONS - Section 6

### Support and Guidance Systems

KabelSchlepp support and guidance systems & accessories help ensure that cable carrier systems have the proper support and alignment as well as a uniform and obstruction free operating surface.

#### SUPPORT TRAYS - For use with nylon polymer or steel carrier systems

For proper operation, when the cable carrier is in a self-supporting chain arrangement the cable carrier must lie down, during the retracting mode, on a clear, flat, and unobstructed surface. If these conditions do not exist, a support tray is required.

Support trays can be ordered in standard widths and lengths **Off The Shelf (OTS)** or custom **Made To Order (MTO)** to suit a specific need. For more information or to discuss the details of your application, please contact the KabelSchlepp design team at 800-443-4216 or submit a request via our website at [www.kabelschlepp.com](http://www.kabelschlepp.com).



**ON-THE-FLOOR**

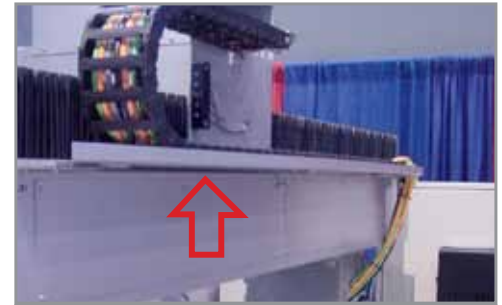

**OFF-THE-FLOOR**

Dependent upon application variables such as environmental factors, location, mounting surface, or whether the support tray will be mounted on the floor or off the floor. Support tray designs and the materials used in their fabrication can vary widely. KabelSchlepp standard support trays are made of zinc plated steel and are available **OTS** for many standard sizes in a single piece tray design. Split rail two piece tray designs are also popular.

#### Typical Support Tray Arrangements

##### Single piece tray design

- standard design OTS

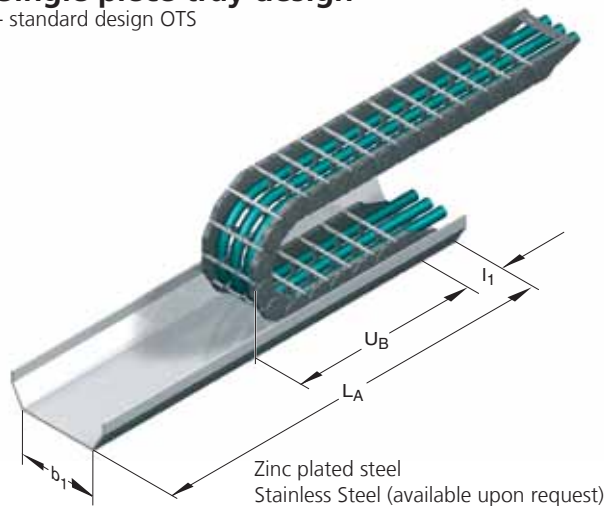

##### Split rail two piece tray design

- special design MTO

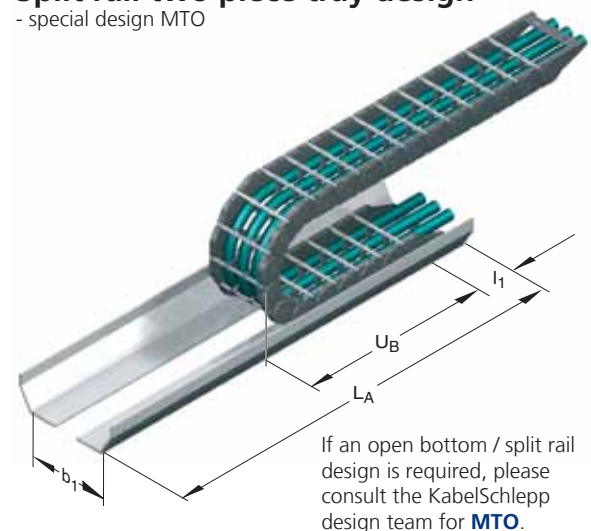

(when standard connecting brackets are used)



$$B1 \text{ min} \approx BK + 0.25 \text{ (6.4)}$$

#### Calculating Support Tray Length

(when standard connecting brackets are used)



$$LA^* = (LS \div 2) + UB + l1$$

\* When strain relief is used, the Support Tray length must be extended accordingly.

#### Abbreviations

- UB** = Depot length
- l1** = End connection/fixing point length
- BK** = Overall width of cable carrier



## CIRCULAR SYSTEMS

### Side Mounted Single-Chain Arrangement with circular guide channel

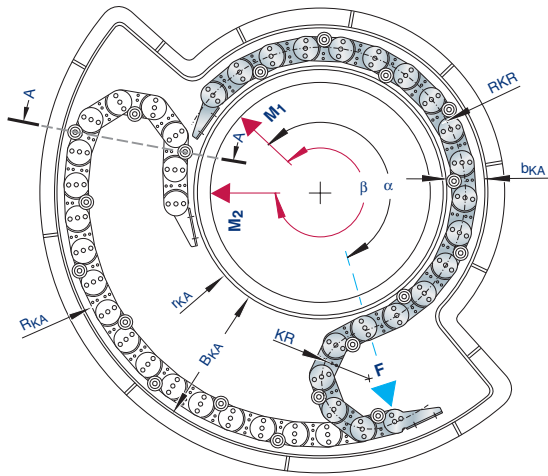

Due to the numerous design options available for circular and rotary motion applications, please contact us for assistance. We can supply a complete solution: ready to assemble, installation included if required.

### Side Mounted Dual-Chain Opposed Circular Arrangement with Distance-Sleigh / Guide Carriage

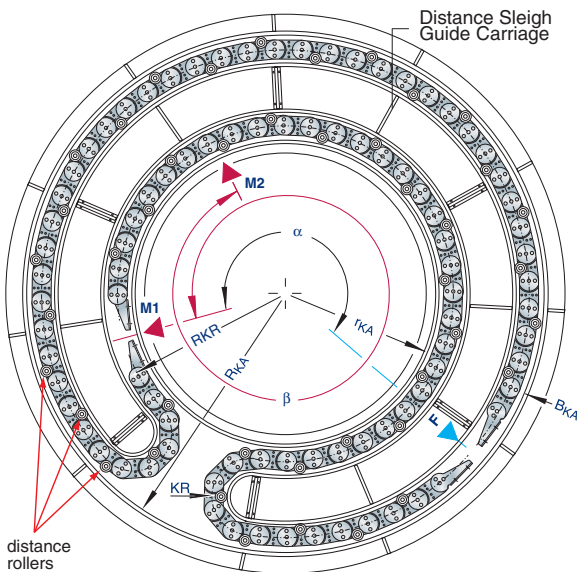

### Single-Chain Arrangement



Circular carrier systems are typically used to manage cables and hoses in applications requiring circular or rotary motion. A single chain arrangement would typically be used in applications where space occupied by the system is not at a premium.

#### Abbreviations:

- $\alpha$  = Fixed point angle
- $\beta$  = Travel length
- $B_E$  = Width of cable carrier
- $b_{KA}$  = Channel width in the narrow section
- $B_{KA}$  = Channel width
- $H_E$  = Height of cable carrier
- $H_{KA}$  = Height of guide channel
- $KR$  = Bend radius
- $RKR$  = Reverse bend radius
- $r_{KA}$  = Internal channel radius
- $R_{KA}$  = External channel radius
- F** = Fixed point
- M 1** = Driver – End position 1
- M 2** = Driver – End position 2

### Circular Guide Channel Channel Cross Sectional View

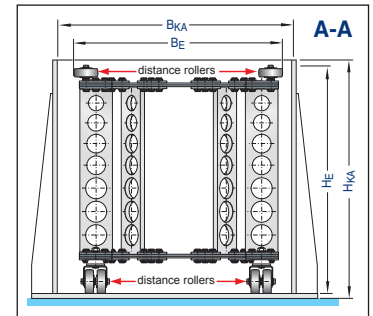

### Dual-Chain Opposed Arrangement



A dual-chain opposed arrangement can be used to effectively double the capacity of cables and hoses that can be managed without having to double the space occupied by the system. A dual-chain arrangement would typically be used in applications with a large or complex cable and hose package.

Also when space is at a premium, a dual chain configuration can be used to effectively reduce the space needed by a similar single-chain system to accommodate the same amount of cables or hoses.

**DESIGN CONSIDERATIONS - Section 7 Extended Travel Systems**

**SUPPORT ROLLERS - Extending travel using Support Roller Systems**

Extended travel systems should be used when the unsupported cable carrier span is exceeded. Support Rollers can be an efficient and cost effective way to extend the travel of cable carrier systems. Support rollers are typically used with steel carrier systems but they can also prove to be an effective solution for extending the travel capabilities of nylon systems as well.

Stationary support rollers are available from KabelSchlepp and should be used for unsupported cable carrier spans that exceed the maximum unsupported lengths listed for the specific cable carrier system selected. Self-supporting information for each carrier type can be found at the beginning of each carrier section throughout the KabelSchlepp catalog.

One support roller provides an absolute maximum travel of 3 times the recommended unsupported length and 2 support rollers provide an absolute maximum travel of 4 times the recommended unsupported length. More than 2 fixed support rollers can not be used since they will interfere with the normal operation of the cable carrier system.

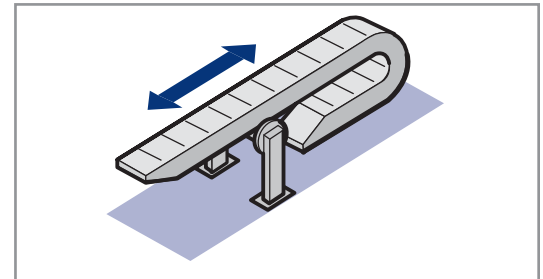

**Self-Supporting Arrangement:**

Unsupported configuration at  $L_S \leq 2 (L_f - k)$  = Normal operation self-supporting

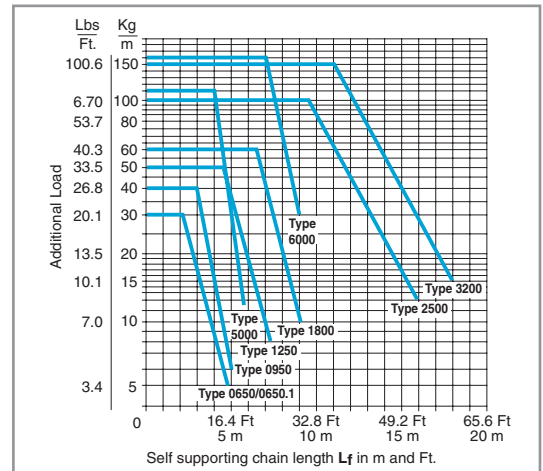
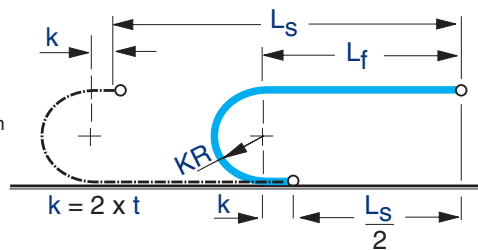

**Arrangement using ONE support roller:**

Configuration with 1 support roller at  $L_S \leq 3 (L_f - k)$   
Total travel capability increased by 50 %

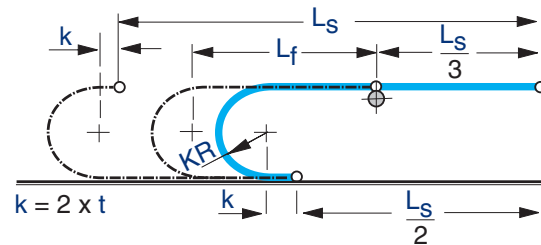

**Arrangement using TWO support rollers:**

Configuration with 2 support rollers at  $L_S \leq 4 (L_f - k)$   
Total travel capability increased by 100 %

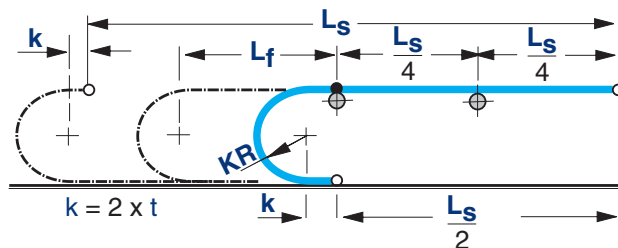

In the case of longer travel length or unusual loads, the carrier should be supported by a carriage system with rollers running on supporting structural channels, ie. see the Rolling Carriage Systems details on pages 2.34-2.35.

Specifications are subject to change without notice.  
KSA-0810-GC



## DESIGN CONSIDERATIONS - Section 7 Extended Travel Systems (continued)

### GUIDE CHANNELS - For use with gliding cable & hose carrier systems

Guide channel systems are required whenever a cable carrier system's unsupported length is exceeded causing the cable carrier to sag so much that the upper and lower runs glide on top of each other. The guide channel is necessary to insure that the sagging and gliding upper cable carrier run is in proper alignment and glides correctly on top of the lower non-moving section (see photo explanation below) insuring long term trouble-free operation.

When considering, designing and ordering a cable carrier system it is important to advise the factory if a guide channel will be installed On-The-Floor or Off-The-Floor:



**OFF-THE-FLOOR**



**ON-THE-FLOOR**

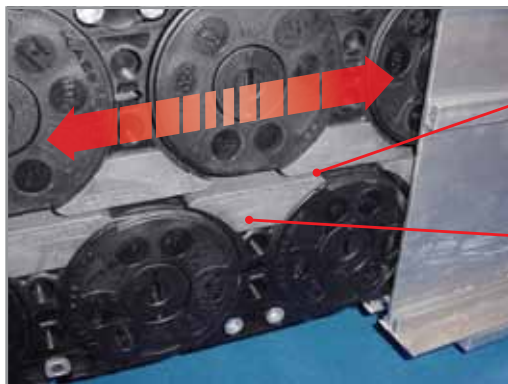

When operating in a properly designed and aligned guide channel, glide shoes will run smoothly on top of each other

Low Friction Material Replaceable Glide Shoes

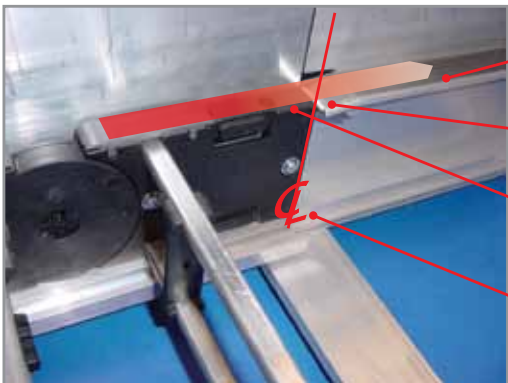

Optional, ultra smooth polished stainless steel surface to dramatically reduce frictional forces on long travel applications.

Lead-in chamfer

Critical interface: Glide Shoe & Glide Strip (extended end of operation) must be level to one another.

Center Point of Total Machine Travel

Dependent upon application variables such as environmental factors, location, mounting surface, or whether the guide channel will be mounted on the floor or off the floor, guide channel designs and the materials used in their fabrication can vary widely. KabelSchlepp Standard guide channels are provided in zinc plated steel. If the application requires, stainless steel and extruded aluminum options are also available. Typical guide channel designs include open-bottom, closed-bottom, and hooded (depicted below).

### Typical Guide Channel Design Options

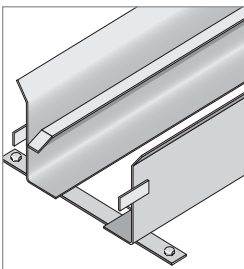

**Open-Bottom:**  
Most economical, allows air-flow, dirt and debris to pass through channel.

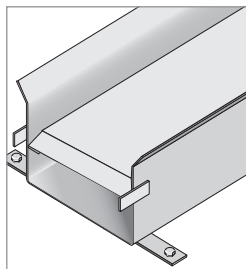

**Closed-Bottom:**  
Traditional design, has solid glide plate across the bottom.

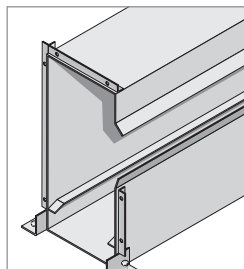

**Hooded:**  
Keeps most debris from damaging chain in channel.

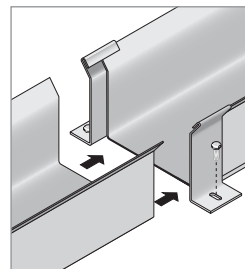

**Side Flanges:**  
One Piece - Keeps side walls in alignment.

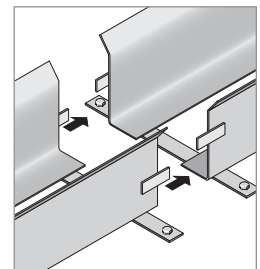

**Side Clips:**  
Clips keep side walls in alignment.



### Guidelines for Guide Channel Installations

1. Each section of the guide channel must be in proper alignment with one another along the entire length of machine travel.
2. There can be no impact point or edge (example: side wall) where the guide channel sections connect to one another.
3. Each section of the guide channel should be properly supported and affixed at either end, at a minimum.
4. The complete guide channel run must be in proper alignment (plumb) with the moving mechanism (drive-arm) of the machine.
5. The guide channel must be installed level down the length of the run and perpendicular to the run; so there is no tipping of the cable carrier guided inside.
6. The generally recommended amount of clearance (gap) between the cable carrier and guide channel inner side wall is 0.125" (3.2 mm) per side or 0.25" (6.4 mm) in total. Smaller cable carrier types (example: Microtrak) may require a slightly smaller gap.
7. The length of the guide channel should "capture" the entire cable carrier, even the "loop depot" (UB) when in its fully retracted position.

#### Extended End of Travel

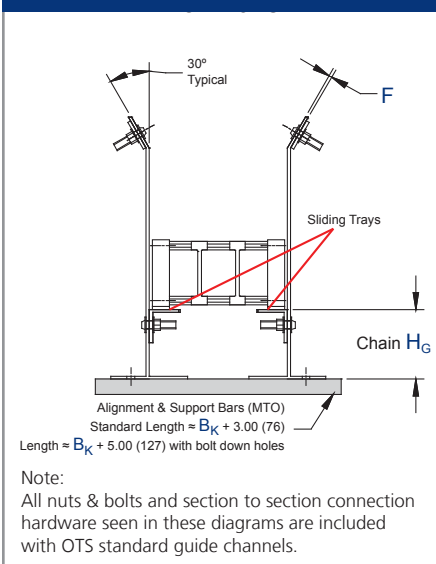

#### Gliding Operation of Travel

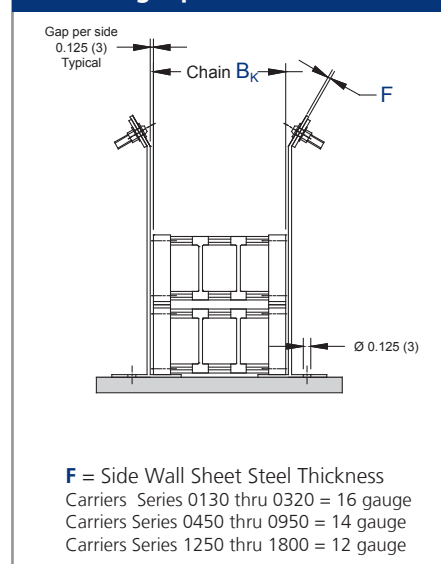

#### Retracted End of Travel

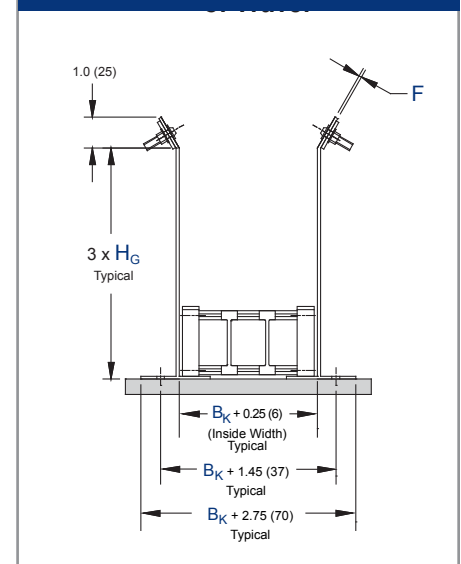

**Alignment & Support Bars:** Are typically required when the guide channel system is mounted off-the-floor and sometimes required for on-the-floor applications. Each bar has 2 holes per end (4 holes per piece). There are 3 pieces per standard guide channel section. These bars are bolted to the bottom of each guide channel section and placed at either end as well as one in the middle.

**Sliding Tray:** Only required on the extended end of travel so the upper moving section of cable carrier can continue to glide smoothly along the entire extended length of travel. Each piece is bolted into place with 3 bolts, two at either end and one in the middle. These are not required when using an opposed (two) cable carrier arrangement.

#### Typical Extended Travel Application With A Guide Channel

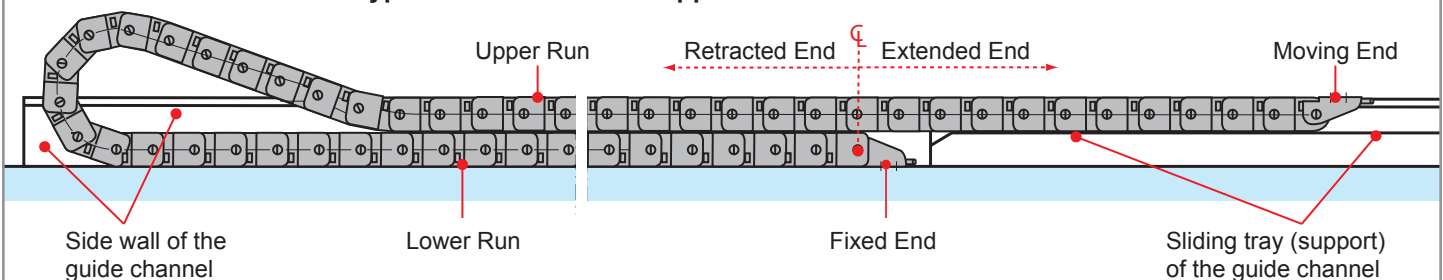



## EXTENDED TRAVEL - DynaGlide<sup>KS</sup> for STEEL Carrier Systems

### DynaGlide<sup>KS</sup> (used with STEEL cable carrier systems)

The unique DynaGlide<sup>KS</sup> system should only be used when the need for a steel chain system is a requirement in an extended travel application exceeding the unsupported length of more than 4x. This system uses the same basic system configuration as an extended travel polymer system gliding in a guide channel. However, it will be significantly heavier, has greater push-pull forces and is more expensive to use than a similarly sized polymer system from KabelSchlepp.

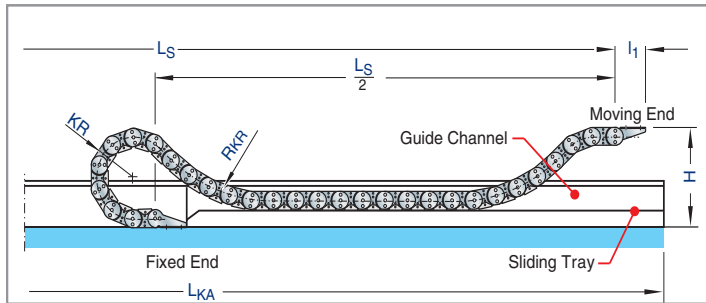

Single-Sided Cable Carrier Arrangement

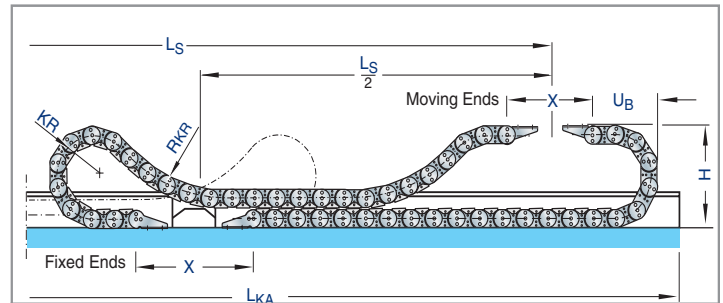

Opposing 2-Sided Cable Carrier Arrangement



$$L_k^* = \frac{L_s}{2} + L_B + KR$$

\*  $L_k$  should be rounded up to the nearest pitch (t)

#### Abbreviations

- $L_k$  = The required/calculated carrier system length
- $L_B$  = The loop length (directly related to the  $KR$ )
- $L_s$  = Total machine travel
- $RKR$  = Reverse bend radius

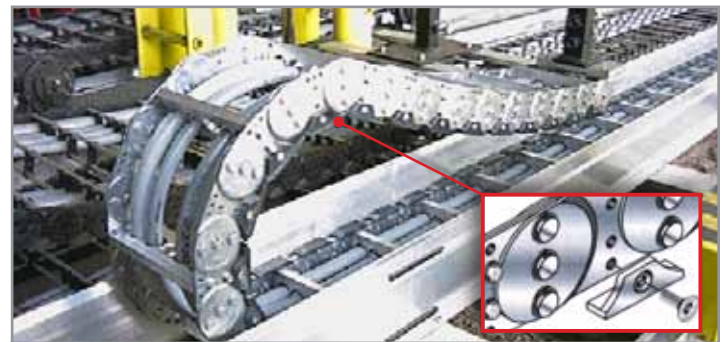

VARITRAK S steel cable carrier with DynaGlide<sup>KS</sup> extended travel system (inset: replaceable glide-shoe detail)



DynaGlide<sup>KS</sup> allows extremely long travel lengths and can be used in standard single system or opposed two carrier configurations.



DynaGlide<sup>KS</sup> can be used with large and small carrier types with a wide variety of bend radius and frame stay system options.

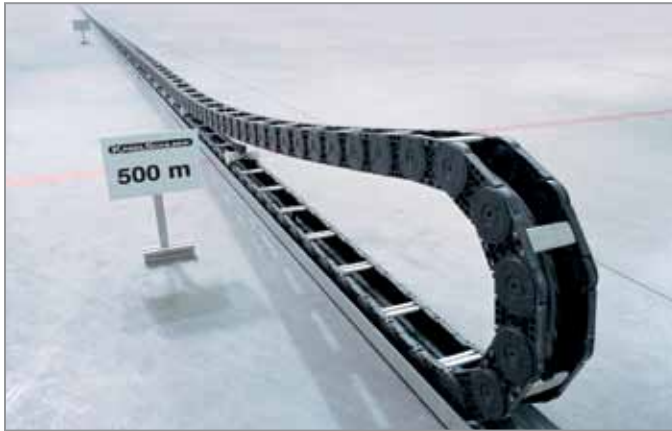

With its **shallow angle of attack** when transitioning into the gliding position, DynaGlide<sup>KS</sup> is ideal for extending the life of cables and hoses in extended travel applications.

**EXTENDED TRAVEL - KabelSkate<sup>KS</sup> for POLYMER Carrier Systems****KabelSkate<sup>KS</sup>** (used with POLYMER cable carrier systems)

The patented KabelSkate<sup>KS</sup> system utilizes a special ultra-light weight rolling carriage placed between the cable carrier's upper and lower runs to dramatically reduce, by more than 95%, the frictional factor and associated push-pull forces during normal operation. This system is ideally suited for highly loaded, extremely long travel (500 meters) applications with speeds up to 3.5 meters per second using an opposed 2 chain arrangement. For long-term trouble free operation the KabelSkate<sup>KS</sup> system does not use a costly guide channel. All that is required is a flat, level and smooth surface to run on outside of any traffic areas



Because the KabelSkate<sup>KS</sup> system is so efficient at eliminating friction, the complete extended travel carrier system can be easily moved by one person without using any additional mechanical aids.



KabelSkate<sup>KS</sup> is so efficient that a towing force of just a few kilograms is enough to ensure that a system load of several tons comprised of the chain, cable, and components can be moved safely and easily.



Flanged rolling casters similar to railway wheels keep KabelSkate's<sup>KS</sup> self-guiding system in perfect alignment over extraordinarily long travel distances without using a guide channel.



## EXTENDED TRAVEL - RollerGlide<sup>KS</sup> for Steel Carrier Systems

The long travel RollerGlide<sup>KS</sup> system was designed for extended travel applications in difficult environments requiring higher load capabilities and lower towing forces. Unlike traditional long travel systems where the carrier system glides on itself or has integrated rolling or gliding carriages, RollerGlide<sup>KS</sup> systems utilize low friction cam followers, rolling on a simple rail system. Using the carrier system's elastically (typical on long travel nylon carrier systems) or mechanically lowered (typical on long travel nylon and steel carrier systems) mounting height, the cam followers are gently lowered onto and/or lifted from the glide rails during normal operation (see diagram and photos below). On nylon systems, cam-followers are replaced with V-Groove wheels that "capture" the angle iron guide rail (see photos below). The entire RollerGlide<sup>KS</sup> system is safely guided by two parallel rails mounted on or off-the-floor. These rails ensure operating accuracy, rigidity and dependability with extremely heavy applied loads and speeds.

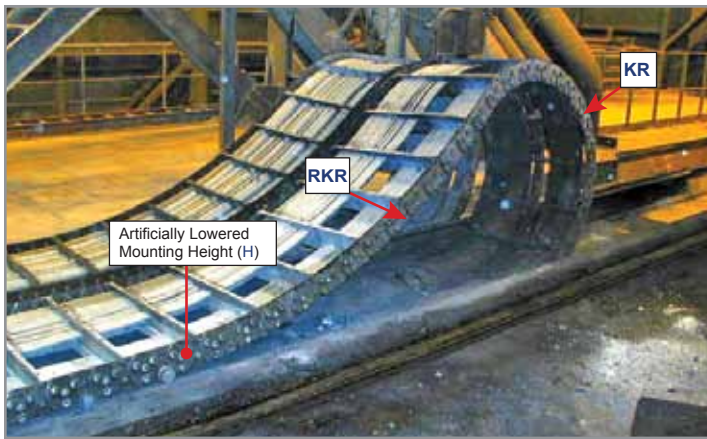
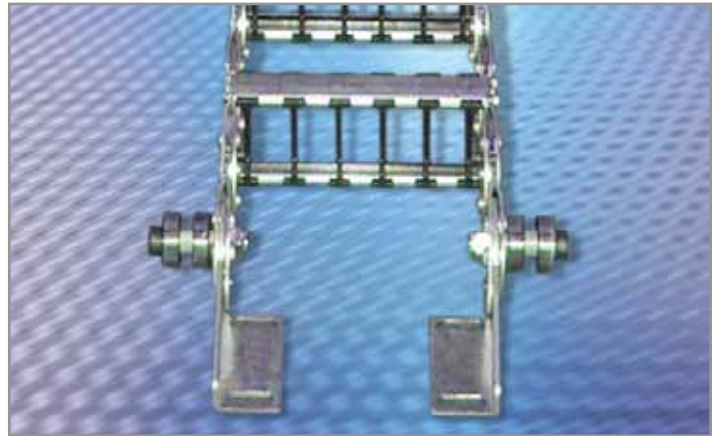

Twin RollerGlide<sup>KS</sup> systems with a mechanically lowered mounting height.

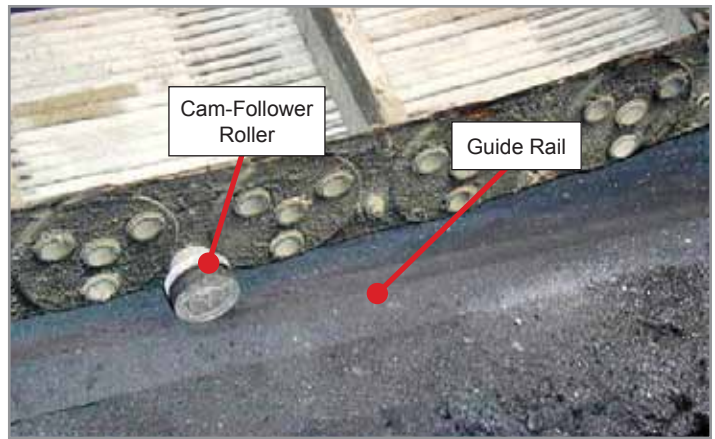

Heavy-duty cam-follower rollers ride on a steel guide rail.



RollerGlide<sup>KS</sup> system with split-bored aluminum LG bar system.

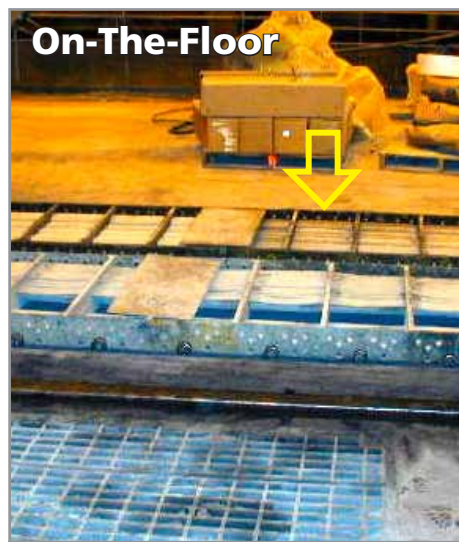

Side view of twin RollerGlide<sup>KS</sup> systems showing a side-by-side configuration mounted on-the-floor.



RollerGlide<sup>KS</sup> showing heavy-duty cam-follower rollers in channel with steel guide rail.

Many RollerGlide<sup>KS</sup> systems have operated reliably for decades in the harshest of environments carrying extremely heavy cable and hose loads. Steel mills, metal foundries and sewage composting facilities are just a few of the extreme operating environments where RollerGlide<sup>KS</sup> systems have proven themselves up to the challenge.



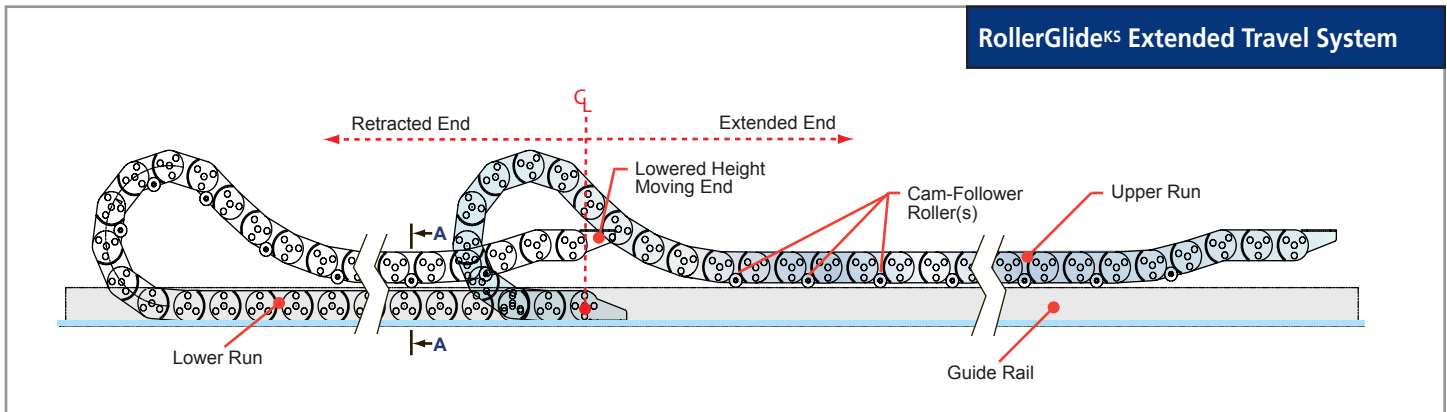

### Key Features

- RollerGlide<sup>KS</sup> systems can be used with mechanically lowered mounting height **steel** systems or **polymer** systems with elastically lowered mounting height.
- The roller system significantly reduces the amount of push-pull forces needed to tow the drive arm over long travel distances.
- Simple yet efficient design ensures system reliability even in the harshest environments.
- When used with VARITRAK systems that have removable frame stays, in-field service of cables and hoses is possible.

### RollerGlide<sup>KS</sup> Cross-Section Detail

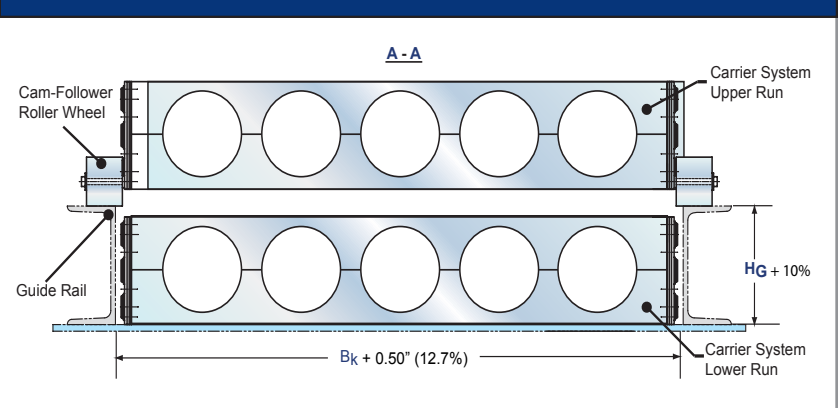

### RollerGlide<sup>KS</sup> Extended Travel System For Nylon Polymer Cable Carrier Systems

#### Off-The-Floor



Nylon polymer cable and hose carrier system with elastically lowered mounting height using RollerGlide<sup>KS</sup> technology to extend travel length capabilities.

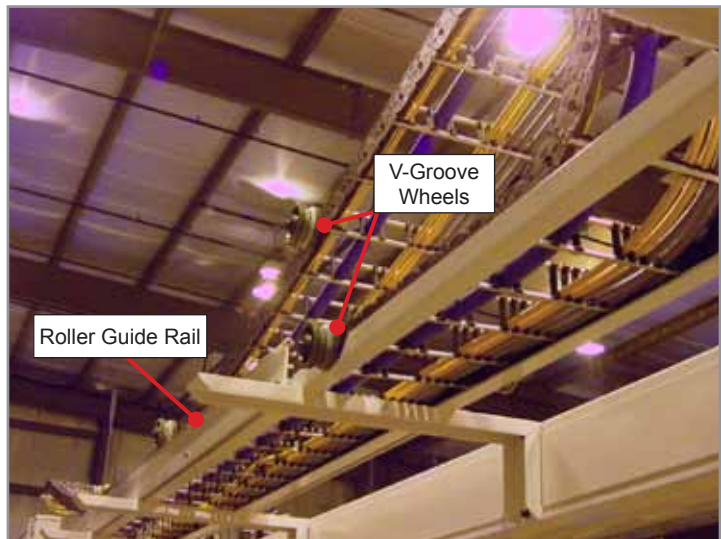

RollerGlide<sup>KS</sup> systems are ideal for heavy applied loads and applications where minimizing push-pull forces is a high priority.



## EXTENDED TRAVEL - Rolling Carriage Systems Type RC 225

### Rolling Carriage Systems

(used with Steel and Nylon Polymer cable carrier systems)

A rolling carriage system can be used for extended travel high speed applications (+1 meter per second) or when the cable/hose loads and operating travel lengths exceed 4x the unsupported length of the specified cable carrier. Unique to KabelSchlepp; Type 222 (drum-roller chain support system (not shown), Type 225 (rolling intermediate support carriage) and Type 228 (captured gliding support carriage – opposed 2 chain arrangements only) systems have proven themselves with more than 4 decades of operation in the harshest of environments. These systems can be designed to operate on the floor or atop a crane bridge.



### Rolling Carriage System Type RC 225 - Single Chain, One Sided Arrangement

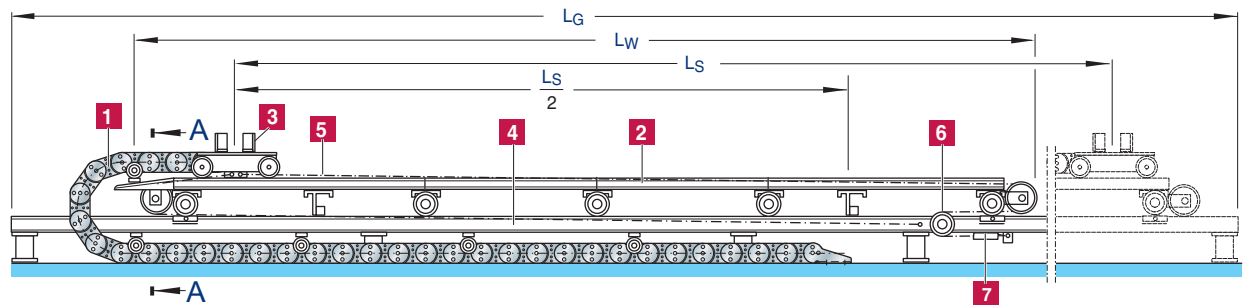

### Rolling Carriage System Type RC 225 - Dual Chain, Opposed Arrangement

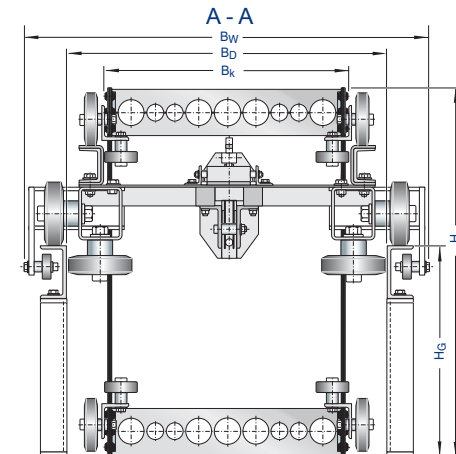
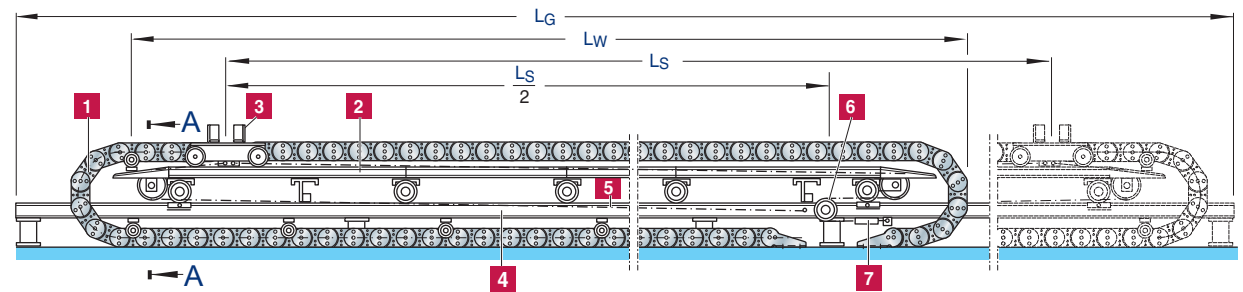

Type RC 225 Side View Schematic

The Type RC 225 Rolling Carriage System consists of the following components:

- 1 Cable carrier(s)**  
with running and guide rollers attached to the side
- 2 Support carriage** with running and guide rollers providing support over the entire length
- 3 Driver carriage**  
with running and guide rollers
- 4 Rolling carriage**
- 5 Tension cable**
- 6 Tension cable roller**
- 7 Tensioning device**

#### Abbreviations

$B_D$	= Clear width in rolling carriage
$B_G$	= Overall width of rolling carriage
$B_k$	= Width of cable carrier(s)
$B_W$	= Support carriage width (max. width)
$H$	= Installation height of cable carrier(s)
$H_G$	= Rolling carriage height
$L_G$	= Rolling carriage length
$L_s$	= Travel length
$L_W$	= Support carriage length

## EXTENDED TRAVEL - Rolling Carriage System Type RC 228

### Rolling Carriage System Type RC 228

For arrangement of cable carriers running in opposite directions.

The opposed cable carriers with running rollers are supported along their entire length by the support carriage which travels with the system.

The support carriage is moved by means of a tension cable system.

This cable carrier system requires less width than the Type 225 cable carrier system. The overall width is only slightly greater than the chain width (**B<sub>k</sub>**).



### Rolling Carriage System Type RC 228 - Dual Chain, Opposed Arrangement

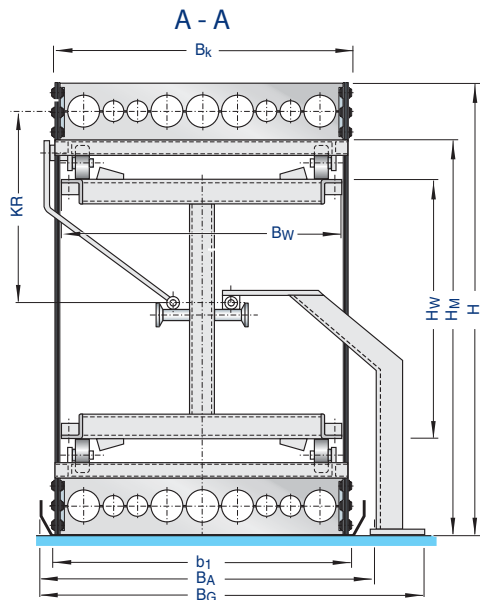
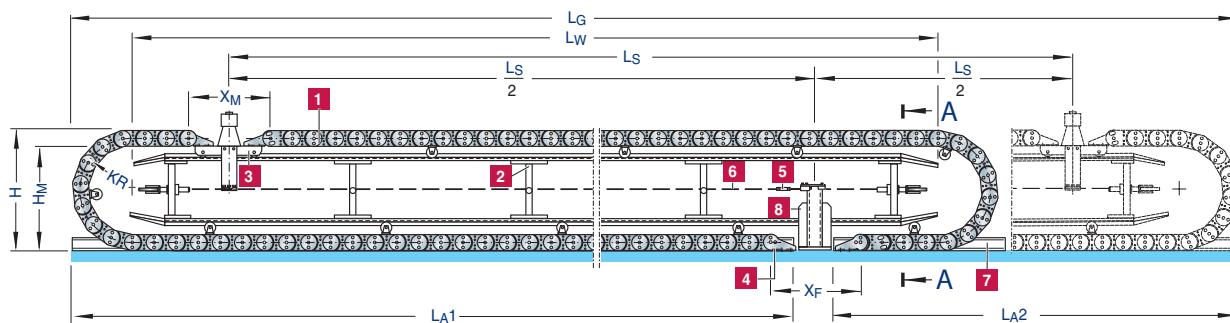

Type RC 228 Side View Schematic

The Type RC 228 Rolling Carriage System consists of the following components:

- 1** Cable carrier(s) with running rollers
- 2** Support carriage, supporting carrier(s) along their entire length
- 3** Driver carriage with running rollers
- 4** Fixed point connection
- 5** Cable tensioning device
- 6** Tension cable with guiding rollers
- 7** Support tray
- 8** Tension cable anchor at the fixed point

#### Abbreviations

- |   |   |
|---|---|
| $B_A$ = Support tray width                  | $K_R$ = Bend radius of cable carriers               |
| $b_1$ = Clear width of support tray         | $L_A$ = Support tray length                         |
| $B_G$ = Overall system width                | $L_S$ = Travel length                               |
| $B_k$ = Cable carrier width                 | $L_W$ = Support carriage length                     |
| $B_W$ = Support carriage width              | $X_F$ = Distance between connections at fixed point |
| $H$ = Installation height of cable carriers | $X_M$ = Distance between connections at driver      |
| $H_M$ = Driver carriage height              |   |
| $H_W$ = Support carriage height             |   |



## DESIGN CONSIDERATIONS - Section 8

# High Duty-Cycle Extended Travel Length Carrier Systems

These general guidelines should be considered when using an extended travel cable and hose carrier system in a high duty-cycle application.



- Use a flat and level guide channel with its side walls consistently parallel to each other and at the prescribed distance (width) between side walls to correctly match the carrier system's overall width.
- The machinery's moving drive-arm must pass through the full length of travel in consistent alignment with the guide channel. (1)
- The machinery's moving drive-arm must be properly squared up to the carrier system and the guide channel itself (i.e. the drive-arm can not be tipped or twisted out of alignment).
- A slick (e.g. polished stainless steel), smooth and preferably metallic gliding surface must be utilized on the extended half of the total travel to reduce friction and drag generated from materials used in long travel gliding carrier systems. (2) Exception "KabelSkate".
- The metallic gliding surface located at the extended half of the total travel must be at the same level as the applicable carrier link height. (2)
- The distance between the gliding surface (extended half travel) and the carrier system itself (retracted half travel), must be one pitch or less of the applicable carrier link. (2)
- The guide channel must be properly and consistently supported from underneath; each section is to be supported in at least 3 places; at either end and in the middle. (3 & 4)
- The side walls of each guide channel section must all be in proper end-to-end alignment for the entire length of travel. Side wall edges and section corners should not protrude unevenly from each other. (5)
- A special hooded guide channel system on the extended half of travel should be considered on any system when the likelihood of carrier "take-off" is great. (carrier take-off is when the carrier system jumps or climbs-up out of its seated position during high acceleration)
- The guide channel must always be kept free and clear of all debris. If the likelihood of debris is high, an open bottom design and/or a covered design (for the entire length of travel) are strongly recommended.
- Luvocom® snap-on and replaceable glide shoes that are molded from a special KS blend of low-friction materials that include Teflon® should be utilized.
- A reduced mounting height equal to 3x the applicable link height must be utilized at the moving end of the carrier system. Note: This will increase the depot length ( $U_B$ ) when the carrier system is in its fully retracted position. (see "Design Considerations - Section 9", #19 for more info)
- The carrier system should have all cable and hose weights evenly distributed, center out.
- All cables and hoses should (if possible) occupy an individual partitioned space within the carrier "frame stay" or cavity of the carrier system. (6)
- All cable and hose lateral free-space allowances should be absolutely no less than outlined in this Technical Handbook.
- All cable and/or hose vertical cavity free-space allowances are to be absolutely no less than outlined in this Technical Handbook.
- All cables and hoses must be properly restrained (clamped into place) at both ends of the carrier system using vibration-proof KS strain relief/clamping systems. (7)
- If guide channel to tow arm alignment is in question, an innovative KS floating tow arm (KS-FTA) should be used. The KS-FTA accepts limited lateral movements between the chain, which must remain centered and aligned in the guide channel, and the drive arm attached to the machinery ensuring the chain runs properly. (8)
- To ensure long term performance, KS designed guide channels are not to be walked-on or have objects placed on or in them.

### DESIGN CONSIDERATIONS - Section 9

## Things To Remember When Designing A Cable Carrier System

- In vertical operating applications (versus horizontal), hanging the loop downward lets gravity work in harmony with the carrier system design, not against it.
- When the operating height is restricted or with circular systems, the carrier system can operate placed on its side, using integral, snapped or bolted-on glide shoes, casters, or rollers.
- As the carrier system travels back and forth between the extended and retracted positions (cycling), an adequate space that is free and clear of all obstructions must be provided for the carrier system to operate correctly and safely. (Equal to 110% of the carrier system's overall operating length x 105% overall width x 110% overall operating height).
- If possible, avoid placing 3 or more similar and/or different cables or hoses into one cavity compartment.
- Maximum recommended cable and hose carrier cavity fill is 60%.
- Do not place cables and/or hoses of different sizes or types (e.g. flat or round) in one cavity compartment without vertical dividers or horizontal shelving between each.
- Always place and/or separate cables and hoses inside the carrier cavity so they move independently and freely of each other.
- Always use cables and hoses that are recommended for continuous flexing operation by their manufacturer.
- Caution should be exercised when using cables with more than 25 conductors. Shifting of the conductors within the cable itself during machine operation can lead to cable failure.
- Always individually clamp down cables and hoses at each end of the carrier system, once the carrier system is installed on the machinery, to prevent them from "walking" into or out of the carrier system during operation. KabelSchlepp's patented cable clamps and/or product specific strain relief clamping brackets should be used.
- Never tie-wrap or fasten cables or hoses onto carrier system links or cross bars.
- Check that all cables and hoses are not installed too tight (stretched between carrier bars) or too loose (hanging on the carrier bars) inside the carrier system when clamping them into place. Optimally, aim for the "neutral axis" (center line of the link) of the carrier system.
- Refrain from using carrier system support rollers on medium to high speed, continuous duty cycle applications. Instead use a KabelSchlepp designed and built rolling-carriage system or gliding systems operating in a properly designed KabelSchlepp guide channel.
- Carrier systems may become unstable when the inner cavity width (**Bi**) is less than **2x** the inner cavity height (**hi**). Especially when the bend radius (**KR**) selected is greater than **3x** the link height.

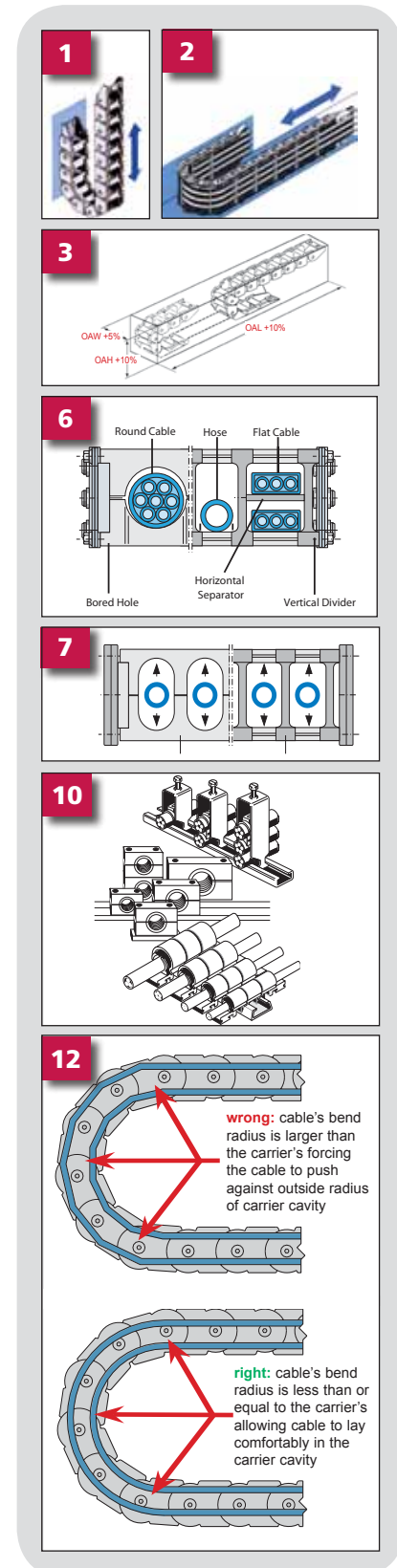



## Important Things To Remember (continued)

15



15. In applications where lateral accelerations in excess of 1 meter/second<sup>2</sup> exist, in either vertical or horizontal applications, it is highly recommended that the section of carrier extending and retracting beyond the loop is properly supported on both sides to prevent the carrier system from flexing out of alignment and being damaged.

16. On extended long travel applications, when using a guide channel system, be absolutely certain that the guide channel sections are properly aligned end to end, with no impact points or misalignments.

17. Never raise the extended half of the gliding channel section above the applicable link height. This will cause an impact point ultimately leading to system fatigue, damage, or catastrophic failure.

18. On high speed (> 10M/Sec<sup>2</sup> and >10M/Sec) applications where the carrier system is in a self-supporting mode, for proper operation and to prevent "hopping" during the retracting mode, angle the driven end connection toward the loop-diameter center line 2° to 3° to give the carrier a slight pre-tension.

19. On heavy and/or extended travel plastic carrier systems with accelerations and speeds in excess of 1 meter/second<sup>2</sup> and 1 meter/second respectively, it is recommended that the moving end (ME) mounting height be lowered equal to 3 x the applicable link height. When this recommendation is applied, care should be taken to either extend the depot 8 x the KR and overall carrier length 16 x the KR to allow for the elasticity factor (tg) or to extend the depot 3 x the KR and add enough reverse bend radii (RKR) links to mechanically lower the moving-end mounting height equal to 3 times the link height.

19

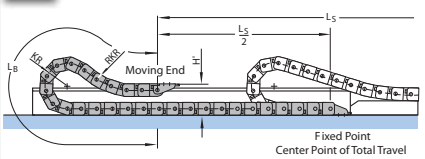

20

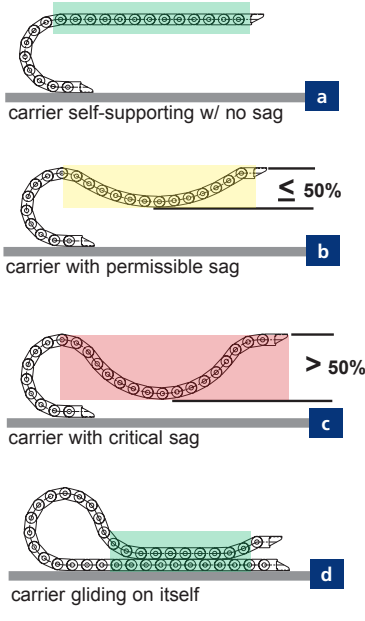

### 20. Operating Modes:

#### a.) Self-Supporting (no sag)

When the carrier fully "bridges" the span between the top of the loop and the moving end in the extended mode without sag due to the system content's weight - this operating mode is RECOMMENDED.

#### b.) Permissible Sag

When the system content's weight (or "applied-load") and extended length span forces the system to sag up to 50% of the loop diameter once fully extended - 50% of the loop diameter sag is the maximum recommended in this operating mode.

#### c.) Critical Sag

When the system content's weight and extended length span forces the system to sag more than 50% and up to 90% once fully extended - this operating mode is not recommended without using a KabelSchlepp designed carrier system guide channel with a reduced mounting height.

**Note:** you can also solve critical sag problems by selecting a sturdier carrier type and style that doesn't have critical sag at the required self-supporting length.

#### d.) Gliding

When the system content's weight together with the extended length force the system to sag all the way down onto itself or the running surface prior to being fully extended - this operating mode is RECOMMENDED only when a KabelSchlepp designed guide channel is to be used!

21. Never grab, hang and/or step on any carrier system irrespective if the system is constructed from nylon or steel, especially when machinery is powered-up.



**DESIGN CONSIDERATIONS - Section 10 Proper Carrier System Installation**

**Proper Installation Of A Cable And Hose Carrier System**



**1. Remove Cables From Reel**

Cables and hoses must not be pulled off the top of the reel, instead properly unroll cables or hoses from their shipment reels or boxes allowing them to relax to prevent twisting, corkscrewing or kinking from developing (see page 2.14 for more information on "The proper unspooling of cables and hoses").

**2. Measure & Cut Required Length**

Carefully measure cable or hose length; reminder: measure twice - confidently cut once.

**Note:** Never measure cable length by placing the cables in a carrier system that is lying flat and then cutting. Always pull the loop over and then measure and cut.



**3. Place Cables and/or Hoses in Proper Cavities**

Care should be taken to correctly place cables and hoses inside the proper carrier cavity by placing them into their correctly specified (per print) location. Cables and/or hoses can be installed into a carrier system either before or after the carrier system is affixed to the machine when using carrier systems with opening cavity access. This makes installing, adding, removing, or replacing cables and hoses on an installed carrier system much easier.

**4. Ensure Proper Fit of Cables or Hoses In Carrier System Cavity**

Cables and hoses should always be placed inside their specific compartments in the carrier system so they can move independently and freely throughout the entire carrier system length. Remember to always apply the recommended minimum cavity area clearances.



**5. Ensure Proper Length of Cable or Hose While In Carrier System**

Check individual cable or hose lengths within the carrier system (once the carrier system is mounted) especially through the bending radius so they are not binding, pinching, or tangling.

**6. Clamp Down Cables and Hoses Off Each End of the Carrier System**

Always individually clamp down cables and/or hoses off each end of the carrier system to prevent them from "walking" into or out of the carrier system during operation. KabelSchlepp designed cable clamps that easily snap together and are vibration-resistant and/or product specific strain relief clamping brackets should be used.



**7. Check Clearance of Operating Envelope**

Make certain the operating envelope of the carrier system has adequate space allowances that are free and clear of all obstructions for the carrier system to operate correctly and safely (110% of the carrier systems overall operating length x 105% overall width x 110% overall operating height).

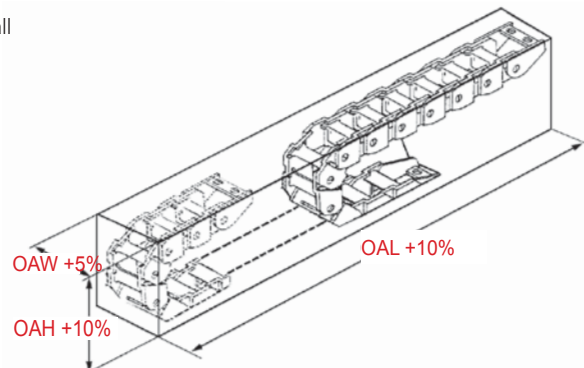



## Proper Carrier System Installation (continued)



When unpacking and installing or dismantling and packing a carrier system, always support the carrier system's weight evenly, taking care not to bridge spans greater than 10 feet unsupported, as well as not to twist or distort the carrier's linear configuration. Link disengagement, side chain band and/or frame stay damage can occur.

If no flat operating surface exists below the carrier system to support it, a support tray should be used. This tray should be installed in alignment with the total machine travel. If the system is self-supporting, this tray should run from the fixed-end location to the end of the carrier loop when fully retracted. If the system is not self-supporting, a KabelSchlepp designed guide channel should be used to fully support and guide the carrier over the entire length of travel.

When installing the mounting brackets, take care that each bracket (especially when each end has two pieces, a left and right side) is properly positioned in direct alignment with the overall carrier system. Misalignment here will cause premature failures.

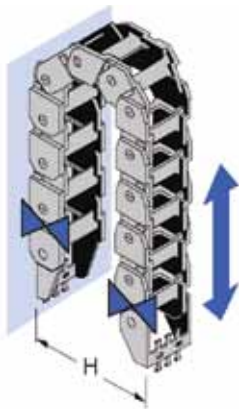

The driven end of the carrier system should always be correctly aligned above or below the fixed-point location to operate correctly.

Once the carrier system is positioned correctly, snugly fasten the mounting brackets to their respective moving (drive arm) and non-moving locations on the machinery with properly sized bolts (furnished by customer).



After the carrier system is properly installed onto the machinery and likewise the cables and/or hoses installed within the carrier system, the entire system should be initially run-off at slow speed to insure that everything runs freely and smoothly without the carrier, cables and/or hoses binding. Any adjustments to the carrier position or alignment as well as cable and/or hose position and length should be done at this time.

Once the entire system is double checked, everything should be firmly tightened down.



Only after this installation and double check procedure is completed should machinery be powered up to full speed and duty cycle.



**DESIGN CONSIDERATIONS - Section 11****Typical Failures And Their Causes****Learn from the mistakes of others**

To better understand the correct function and design of cable & hose carrier systems, it is wise to also look at typical failure modes such as those pictured on the following pages. By applying the technical information and recommendations written and seen in this Technical Handbook as well as using the technical expertise and assistance of KabelSchlepp engineers such failures can be avoided.

**Catastrophic Cable Failure****Cables torn in two pieces**

**Possible Causes:** cable length inside of the cable carrier system incorrect, improper type of cable, maximum cavity fill exceeded, lack of cable strain relief/clamping.

**Premature Cable Failure****Cable snaking and severe cable jacket wear**

**Possible Causes:** lack of sufficient cavity partitioning systems, incorrect type of cable, cavity fill exceeded, lack of cable strain relief/clamping, incorrect carrier for application, sloppy installation.

**Catastrophic Cable Failure****Severe cable "cork-screwing" and conductor failure**

**Possible Causes:** incorrect type of cable for the application, cavity fill exceeded, lack of cable strain relief/clamping.



## Typical Failures And Their Causes (Continued)



### Carrier System Failure

#### System and component failure

**Possible Causes:** incorrect carrier design and type specified for application, application exceeded carrier design limits. Possible obstruction to carrier travel path.

### Cable Premature Wear + Failure

#### Pinching and choking of cables and hoses

**Possible Causes:** incorrect design, overfilling of carrier cavity after delivery, initial design does not match actual installation requirements.

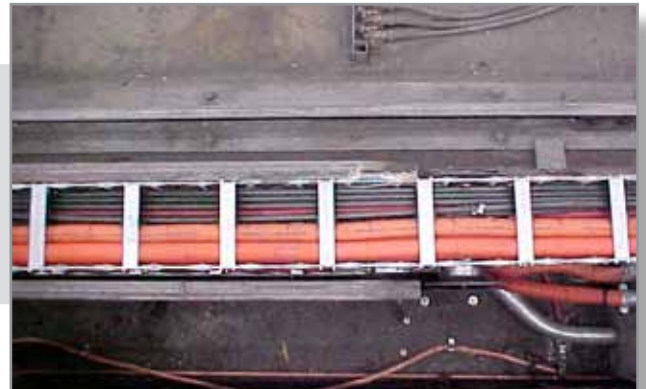

### Carrier System Failure

#### Carrier links and component failure

**Possible Causes:** incorrect carrier type and size selected for application, incorrect carrier material for application, overloaded carrier system, possible obstructions in carrier system travel path.

### Carrier System Failure

#### Partially disengaged links "broken back"

**Possible Causes:** incorrect carrier type for application, overloaded carrier system, no carrier system back support.





### Carrier Failure

#### Fatigued and severed tube

**Possible Causes:** incorrect carrier for application, cavity fill limits exceeded, minimum radii requirements overlooked, application exceeds carrier bending fatigue limits.

### Catastrophic Cable Failure

#### Extreme cable movement within carrier system

**Possible Causes:** incorrect cable for application, missing cable strain relief, insufficient cavity partitioning.



### Carrier System Failure

#### Obstruction within operating envelope and tearing into carrier system

**Possible Causes:** misaligned carrier system, incorrect installation, inadequate inspections, application modifications after initial carrier system installation, carrier design incorrect for application, limited carrier envelope space.

### Cable & Carrier System Failure

#### Trying to fit "8 gallons into a 5 gallon pail"

**Possible Causes:** classic over filling of cavity space, carrier design incorrect for application, limited carrier envelope space yet additional cables/hoses added anyway (after the fact), overloaded carrier system, no cable/hose strain relief.





## DESIGN CONSIDERATIONS - Section 12

## Shipping, Transport And Storage

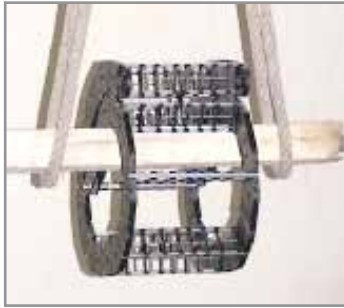

1) KabelSchlepp carrier systems are precision stamped, molded, extruded and assembled products and therefore must be guarded against sudden impacts, twisting and compression loads (example: stacking pallets and crates during transport) during shipment and unpacking.



2) When unpacking and installing or when dismantling and packing a carrier system, always support the carrier system weight evenly, taking care not to bridge spans greater than 10 feet unsupported, as well as not twist or distort the carrier's linear configuration.

3) Take care when handling carrier systems to prevent injury and product damage. Carrier systems can be cumbersome and difficult to handle due to their size, configuration and weight, which is often difficult to immediately assess by unfamiliar parties.

4) Never lift a carrier system that has been factory packed and shipped in a coiled and banded configuration (laid on its side, strapped to a pallet) by an individual link or mounting bracket. Always evenly distribute weight with a pick-up beam or rod through the center of the coiled system when lifting and/or positioning.



5) Super-duty, large or extremely long carrier systems are often shipped in segments with their ends tagged for correct and easy on-site handling, positioning and assembly. The tags should not be removed until assembly.

6) Do not store zinc plated steel carrier systems near humid or green sea (salt water) environments.

7) Avoid storing standard nylon carrier systems outdoors exposed to UV rays or exposed to cold and dry temperatures for prolonged periods below 0° C or above 85° C.



For the benefit of the environment ...

... KABELSCHLEPP plastic cable carriers are 100% recyclable!

**DESIGN CONSIDERATIONS - Section 13**

**Preventative Maintenance Checks And Inspections**



Always schedule regular carrier system inspections, no less than twice a year, to reduce the probability of unforeseen or avoidable damage and/or failure.

**Standard carrier system inspections should include:**

1. Clear out any and all debris and grime in the path of the carrier systems operation. Steel and nylon chain links do not require any grease/lubrication.
2. Replace all damaged, worn or separated links.
3. Replace all damaged, worn or unlocked cavity cross bars.
4. Replace all damaged, worn or unlocked cavity vertical dividers or horizontal shelves.
5. Tighten, repair or replace all missing or damaged cable and hose strain relief.
6. Replace all worn, torn, ripped or damaged cables and/or hoses and find the root cause for these conditions - e.g. incorrect cable/hose type, jacket type, fit in cavity, strain relief and/or cable or hose length - then correct accordingly.
7. Replace or repair damaged or disengaged links at mounting bracket interface point.
8. Make sure all mounting bracket screws are tight and mounting brackets are properly aligned.
9. Check alignment of machine's drive-arm to the total travel of the carrier system and when applicable guide channel.



**For long travel systems gliding on themselves in a guide channel add the following steps:**

10. Replace all links exhibiting accelerated wear typically seen in first 2 meters of carrier length at both the moving and fixed end.
11. Repair or replace any and all damaged or deformed gliding plate sections of the guide channel (beginning at the center point of total travel and extending to the far end of the fully extended travel).
12. Clean out any dirt and debris from the entire length of the guide channel.
13. Replace any and all excessively worn glide shoes, buttons, or rollers.





## Step 8 Placing An Order

Prior to placing an order, you should have determined the following key pieces of information:

If you need additional assistance in specifying the best cable carrier for your application, complete the Carrier Application Data & Quote Request Sheet and submit it to our Application Engineering Department for a complete solution.

- 1) The complete cable & hose package that the carrier system is to manage (please list brand, type, weight, size (**O.D.**) of each, quantity, and the manufacturer's minimum bend radius specifications)
- 2) The carrier product group type selected
- 3) The carrier type and size system (**h<sub>i</sub>**) from this group
- 4) The carrier cavity inner width (**B<sub>i</sub>**) selected
- 5) The frame stay bar system type selected



### If Applicable:

- i) The number and placement (**submit sketch!**) of vertical dividers required per link
- ii) The number and placement (**submit sketch!**) of horizontal shelves required per link
- iii) The installed interval of the aforementioned vertical and/or horizontal partitions for example, every other link (default), or every 3rd, 4th, etc. link

- 6) The carrier bend radius (**KR**) selected
- 7) The total number of links/ ( $\sum t$ ) required or system length (**L<sub>k</sub>**) rounded to the nearest link pitch
- 8) The type and position of mounting brackets required
- 9) If already quoted, list the price, date quoted, and KabelSchlepp quote number
- 10) The number of complete systems required

**The aforementioned information should be stated on your confirming purchase order and can be submitted to our factory by:**



**Fax: 1.414.354.1900**

**E-mail: [sales@kabelschlepp.com](mailto:sales@kabelschlepp.com)**

**Internet: [www.kabelschlepp.com/order.htm](http://www.kabelschlepp.com/order.htm)**



## CARRIER APPLICATION DATA & QUOTE REQUEST SHEET

Please answer all of the questions listed below completely and accurately! Please print (or type) legibly!  
Fax (1-414-354-1900), mail to KabelSchlepp, or submit this form online at <http://www.kabelschlepp.com/carrier/devsht.htm>

### Required Customer Data:

Contact (Engineering) Name: \_\_\_\_\_  
Contact (Purchasing) Name: \_\_\_\_\_  
Company Name: \_\_\_\_\_  
Telephone Number: \_\_\_\_\_ Telefax Number: \_\_\_\_\_

### Required Background Information:

Application Description/Your Objective: \_\_\_\_\_  
Machine Name/Model/Type: \_\_\_\_\_  
This Machine is a: One Off: \_\_\_\_\_ Prototype: \_\_\_\_\_ In Production — Manufactured Per Month: \_\_\_\_\_

### Required Application Data:

Any notable environmental influences: \_\_\_\_\_  
• Operating temperatures? \_\_\_\_\_ • Corrosives? \_\_\_\_\_  
• Red hot chips present? \_\_\_\_\_ • Abrasives? \_\_\_\_\_  
Total machine travel? \_\_\_\_\_ inch/mm (circle either inch or mm)  
Is the carrier's fixed point located at the center of the total machine travel? \_\_\_\_\_ (yes/no)  
If not, please list the distance off-center \_\_\_\_\_ inch/mm (circle either inch or mm)  
Please identify the travel orientation, for example "Horizontal", "Circular", etc.: \_\_\_\_\_ (list)  
Operating Speed: Less than 5 ft/sec.? \_\_\_\_\_ Less than 10 ft/sec.? \_\_\_\_\_ Greater than 10 ft/sec.? \_\_\_\_\_  
If known or qualified, what is the machine's acceleration? \_\_\_\_\_ ft/sec.<sup>2</sup>

### Carrier Contents:

### Carrier Type Requested:

Please list all contents; cables and/or hoses, their respective weights, outside diameters and minimum bend radius.

Cables				Hoses			
No.	Weight	O.D.	Min. Bend Radius	No.	Weight	O.D.	Min. Bend Radius

### Dimensional Limitations:

Carrier's operating envelope dimensions:  
(Please note: KSA allows an additional 2 inches (OAH) for operating clearance!)

OAW = \_\_\_\_\_ inches ( \_\_\_\_\_ mm)  
OAL = \_\_\_\_\_ inches ( \_\_\_\_\_ mm)  
OAH = \_\_\_\_\_ inches ( \_\_\_\_\_ mm)

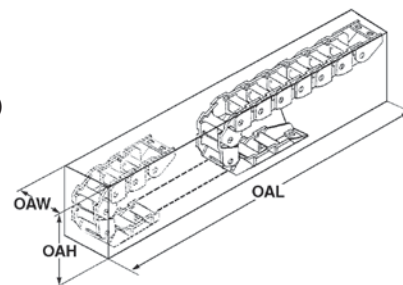

Describe any obstructions: \_\_\_\_\_

### Requested Carrier Features and/or Accessories:

Enclosed Tube <input type="checkbox"/>	Hinged Opening Lids <input type="checkbox"/>	Dividers <input type="checkbox"/>
Open Design <input type="checkbox"/>	Hinged/Twist Opening Bars <input type="checkbox"/>	Support Rollers <input type="checkbox"/>
Cable/Hose Clamps <input type="checkbox"/>	Guide Channels/Support Trays <input type="checkbox"/>	

**See PRINT Attached**

Specifications are subject to change without notice.  
KSA-0810-GC

Phone: 414-354-1994  
Fax: 414-354-1900

[www.kabelschlepp.com](http://www.kabelschlepp.com)  
[info@kabelschlepp.com](mailto:info@kabelschlepp.com)

KabelSchlepp America, Inc.  
7100 W. Marcia Road, Milwaukee, WI 53223 - USA

